

FUTURE OF THE TE AWA KAIRANGI/ HUTT RIVER CORRIDOR

ENVIRONMENTAL AND RECREATIONAL MANAGEMENT PLAN AND OPERATIONS MANUAL

MARCH 2022



DOCUMENT QUALITY ASSURANCE

BIBLIOGRAPHIC REFERENCE FOR CITATION:

Boffa Miskell, 2020. *Future of the Te Awa Kairang/Hutt River Corridor: Environmental and Recreational Management Plan and Operations Manual*. Report by Boffa Miskell Limited for Greater Wellington Regional Council.

PREPARED BY: Emma McRae
Landscape Architect/ Associate Principal
Boffa Miskell Ltd

REVIEWED BY: Boyden Evans
Landscape Architect/Partner
Boffa Miskell Ltd

STATUS: [DRAFT] Revision / version: 4 Issue date: March 2022

File ref: Hutt River Corridor Management Plan_20220324_Final

Cover photograph: Hutt River, © Boffa Miskell, 2020

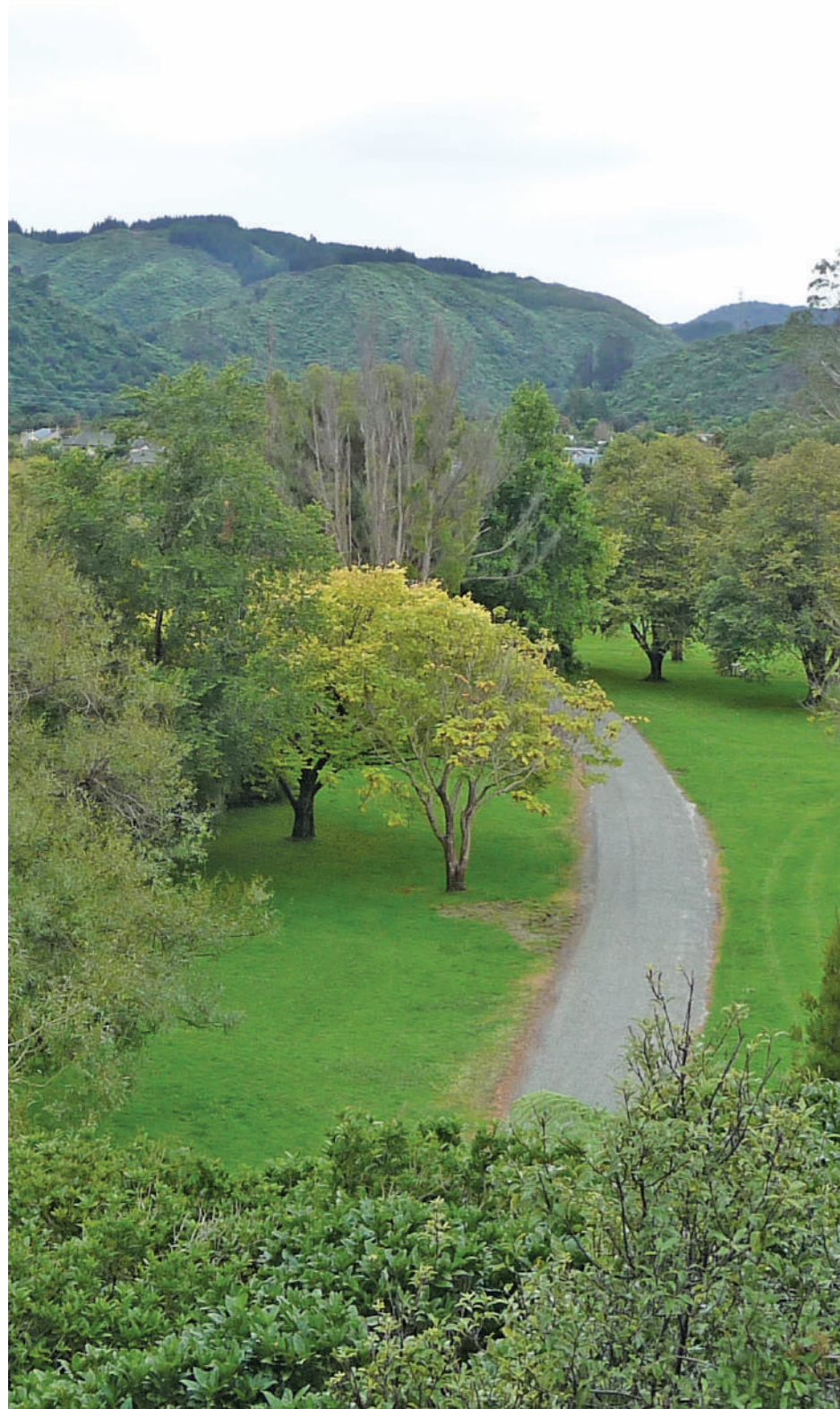

CONTENTS

INTRODUCTION	6	PROJECT AREAS	26
PURPOSE AND SCOPE	6	MANOR PARK/POMARE	26
RELATED DOCUMENTS	7	MANOR PARK NORTH	27
PLAN RELATIONSHIPS	8	SILVERSTREAM TO MOONSHINE	28
CORRIDOR-WIDE ISSUES	9	ISSUES AND ACTIONS	28
GENERAL ISSUES	9	PROJECT AREAS	29
MANAGEMENT PRINCIPLES	10	SILVERSTREAM	29
RIVER KNOWLEDGE AND ASSETS	11	TRENTHAM	30
WATER QUALITY	12	MOONSHINE TO TOTARA PARK	31
PROJECT ACTIONS	14	ISSUES AND ACTIONS	31
ESTUARY TO EWEN	17	PROJECT AREAS	32
ISSUES AND ACTIONS	17	POETS PARK	32
PROJECT AREAS	18	TOTARA PARK FOREST	33
WAIONE STREET BRIDGE	18	TOTARA PARK TO BIRCHVILLE	34
STRAND PARK AND AVA PARK	19	ISSUES AND ACTIONS	34
EWEN TO KENNEDY GOOD	20	PROJECT AREAS	35
ISSUES AND ACTIONS	20	TOTARA PARK CONNECTIONS	35
PROJECT AREAS	21	BIRCHVILLE TO TE MARUA	36
TIROHANGA WETLAND ²¹		ISSUES AND ACTIONS	36
KENNEDY GOOD TO POMARE RAIL BRIDGE	22	PROJECT AREA	37
ISSUES AND ACTIONS	22	TE MARUA	37
PROJECT AREAS	23	DESIGN GUIDE	39
BELMONT/AVALON	23	TRAILS AND SURFACING	39
TAITA ROCK	24	TRAILS AND SURFACING - TYPICAL DETAILS	40
POMARE TO SILVERSTREAM	25	VEHICLE CONTROL	41
ISSUES AND ACTIONS	25	INFORMAL VEHICLE BARRIERS	41



VEHICLE CONTROL	42	1. RELIABLE PIONEERS	67
PARKING HUBS	42	2. NATIVE GROUND COVERS	68
FORMAL VEHICLE BARRIERS	42	3. COASTAL/TIDAL INFLUENCE	68
VEHICLE BARRIERS - TYPICAL DETAILS	44	4. ENHANCEMENT PLANTING	69
FURNITURE AND FACILITIES	45	5. SMALL STREAM PLANTING	70
TOILETS, FACILITIES AND FURNITURE	45	6. AMENITY AREAS	71
TRAIL FURNITURE - TYPICAL DETAILS	46	<hr/>	
SIGNAGE AND WAYFINDING	47	SITES OF SIGNIFICANCE TO MANA WHENUA	72
PLANTING AND REVEGETATION	55		
BUFFER ZONE PLANTING	57		
SMALL STREAM RIPARIAN PLANTING	57		
WILLOW POLE BUFFER ZONE PLANTING	57		
MIXED WILLOW AND NATIVE BUFFER PLANTING	59		
RIVER BERM PLANTING	60		
NATIVE PLANTING WITH HARD STRUCTURE PROTECTION	60		
BERM PLANTING – SECOND LINE	60		
BERM PLANTING - DISCRETE GROUPS	61		
<hr/>			
PLANTING MAINTENANCE	63		
TIMELINE FOR ESTABLISHING NATIVE PLANTING	63		
WILLOW PLANTING	64		
ADAPTING ESTABLISHED WILLOW PLANTING	65		
NATIVE REGENERATION UNDER ESTABLISHED WILLOWS	65		
RIPPING INTO ESTABLISHED WILLOW	65		
OLD WILLOWS IN NEED OF REJUVENATION	66		
<hr/>			
PLANTING LISTS	67		

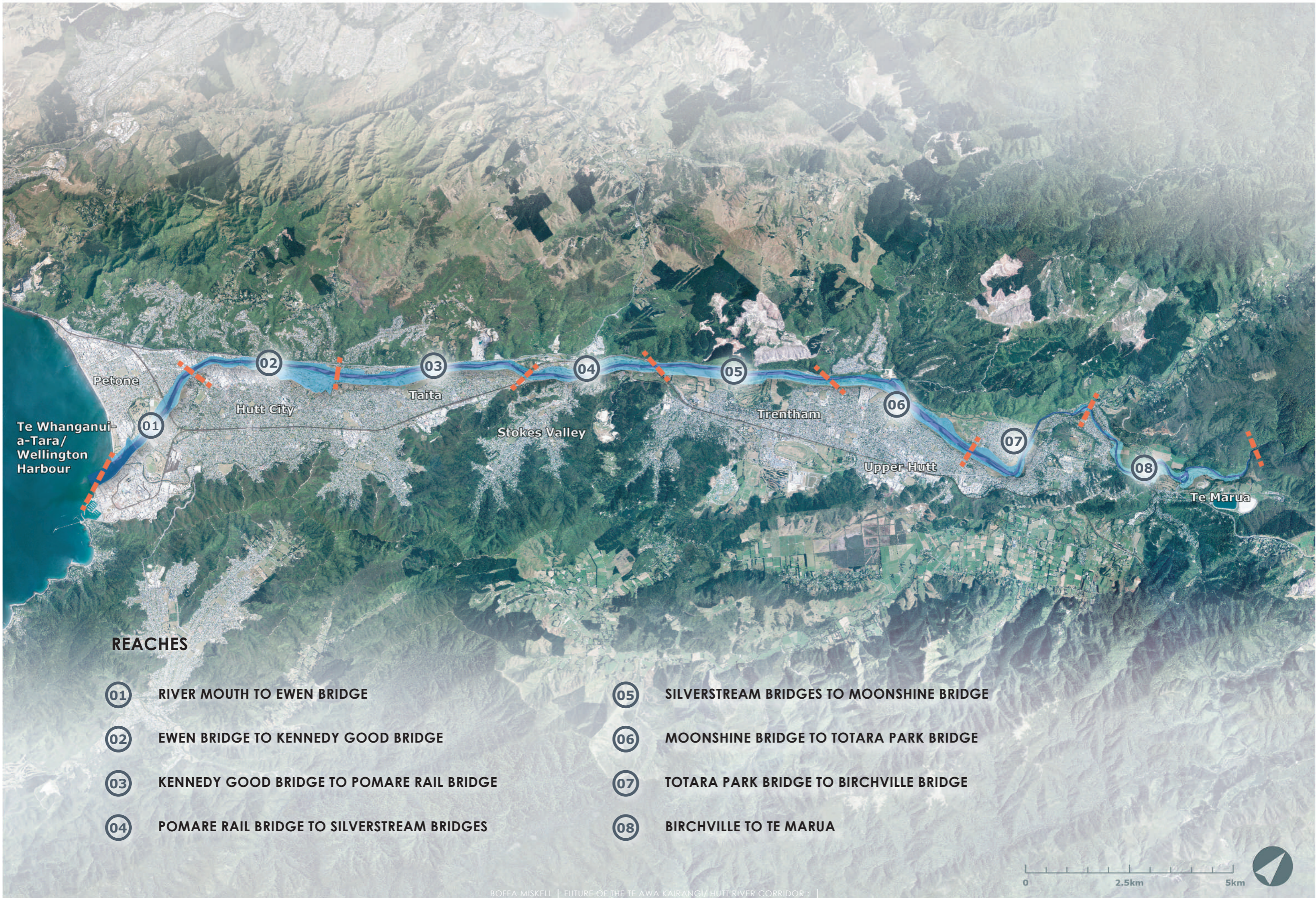

INTRODUCTION

PURPOSE AND SCOPE

An environmental strategy for the Te Awa Kairangi/ Hutt River corridor is set out in the 2018 Te Awa Kairangi / Te Awa Kairangi/ Hutt River Environmental Strategy Action Plan (ESAP). The ESAP set out what is needed to achieve the aims and objectives identified by the community for the management and enhancement of the river corridor environment.

The Future of the Te Awa Kairangi/ Hutt River Corridor is a management and operations handbook builds upon the environmental strategy, providing a blueprint for how the actions identified in the environmental strategy will be implemented.

The Future of the Te Awa Kairangi/ Hutt River Corridor therefore covers:

A handbook which sets out issues and actions of management and how these should be achieved. It provides the framework within which all future management of a property or area will be carried out and describes it in a way which will be readily understood by all who might be affected. The management handbook has several requirements:

1. It must be comprehensive; omissions give rise to ambiguity and misinterpretation
2. It must be pragmatic and permit some flexibility within prescribed limits.
3. It must be clear and concise.
4. It must provide for review so that changing circumstances can be taken into account.

An operations manual addresses actions at a finer scale and in greater detail to guide how development and maintenance activities are to be carried out.

The area covered by the handbook runs from Kaitoke Regional Park in the north to Seaview Marina. Most of the land is in public ownership, administered by Greater Wellington Regional Council (GWRC), Upper Hutt City Council (UHCC) or Hutt City Council (HCC). The development of this handbook has involved consultation with these agencies.

Key issues of the river corridor include management issues accommodating steadily increasing numbers of visitors and users, demands on the area and resource, toxic algae, fly tipping and flooding.

The type of trail and trail access is also a key issue. Resolving areas of pedestrian and vehicle conflict will be an important factor in determining the type and locations of access. Parking areas may require formalising or better advertising. Pedestrian walking loops from local areas which take in part of the trail are also a feature desired by local residents.

Management of willow planting which was established to maintain river banks is now obstructing views and access towards the river in some locations. The provision of suitable trail furniture in the right locations can be complemented with signage for wayfinding and interpretive signage which tells the stories of the river.

This handbook follows the structure of the Environmental Strategy document, covering the same identified sections of the river, with identified projects and priorities for each area.

Major capital works have not been included in this management plan, these projects would be subject to preparation of a business case and a separate specific brief.

Projects and Tasks are grouped geographically, in line with the Environmental Strategy, under the following sections:

- Estuary – Ewen
- Ewen - Kennedy Good
- Kennedy Good – Pomare Rail Bridge
- Pomare Rail – Silverstream
- Silverstream – Moonshine
- Moonshine – Totara Park
- Totara Park – Birchville
- Birchville – Kaitoke Regional Park

A table of river-wide issues is supplied overleaf.





RELATED DOCUMENTS

The 2001 Te Awa Kairangi/ Hutt River Floodplain Management Plan (HRFMP) was developed over 10 years by community groups and organisations in the Hutt Valley and reflects how these parties believe the flood risk from the Te Awa Kairangi/ Hutt River should be managed.

The plan outlines a holistic approach to flood protection, combining physical protection (such as stopbanks and river realignment) with non-structural measures (such as appropriate land zoning and preparing communities for flooding). It also looks at environmental opportunities and ways to enhance the river environment.

The 2018 Te Awa Kairangi / Te Awa Kairangi/ Hutt River Environmental Strategy Action Plan ('Environmental Strategy') provides a vehicle to achieve many of the HRFMP's environmental and community outcomes. The Environmental Strategy is governed by the HRFMP's principles, so proposals contained within do not compromise the integrity of the flood defence system and flood risk management methods.

The objectives and actions identified in the Environmental Strategy provide the starting point for developing this management plan and operations handbook.

The handbook, The Future of the Te Awa Kairangi/ Hutt River Corridor follows the structure of the Environmental Strategy document, covering the same identified sections of the river, with identified projects and priorities for each area.

This handbook has been designed for both authorities and organisations who have a role in the management of and activities associated with the corridor.

RELATED DOCUMENTS

PLAN RELATIONSHIPS

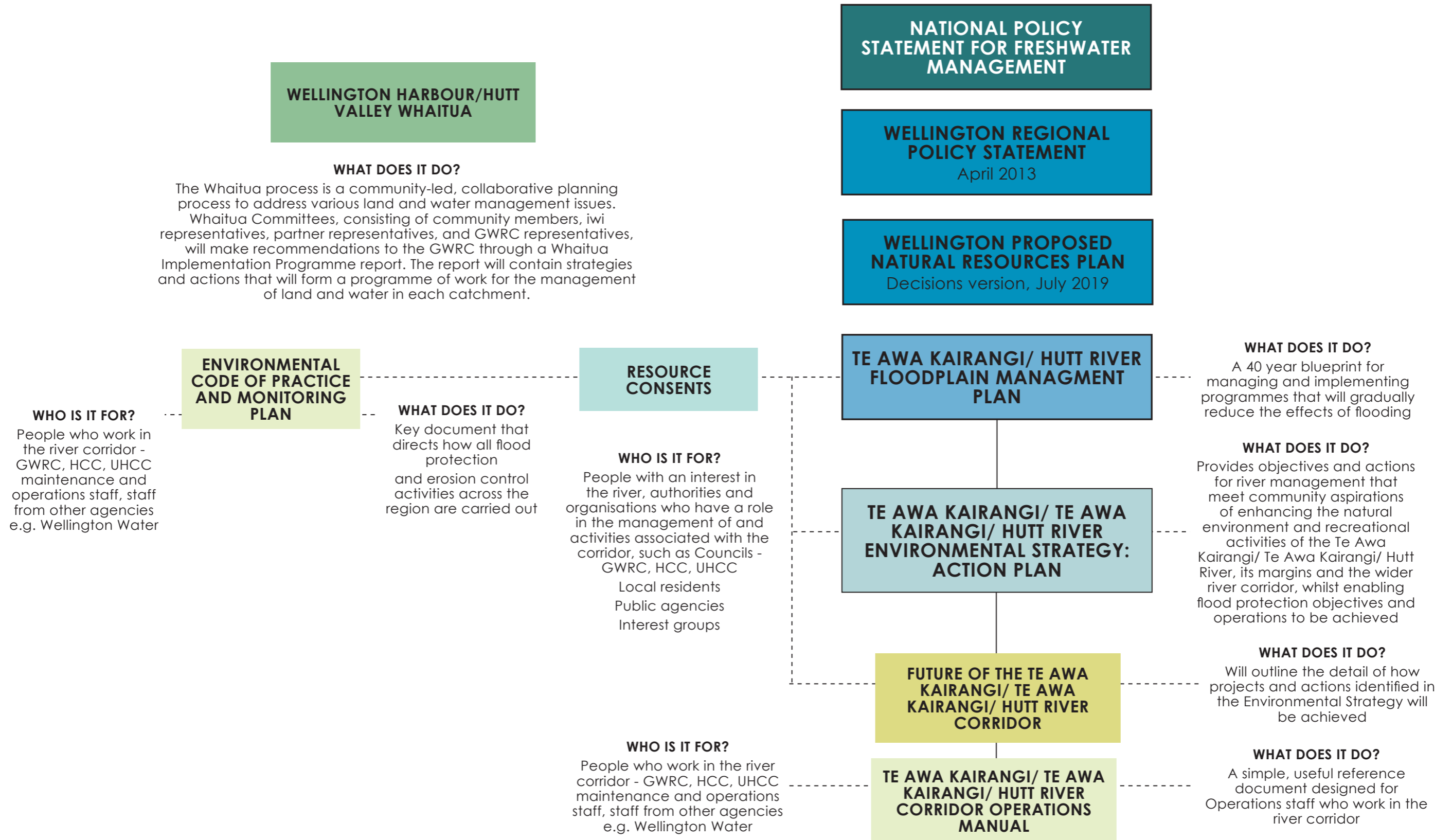

CORRIDOR-WIDE ISSUES

GENERAL ISSUES

Identified issues to be covered for each section of the river corridor are outlined below and include (but are not limited to):

TRAILS AND SURFACING

- Establish rationale for surfacing types used in particular areas
- Resolve conflicts relating to surface types and maintenance requirements
- Trail specific design and maintenance guidelines – details to go into Operations Manual

TRAFFIC MANAGEMENT

- Establish clear rationale for areas where vehicles are permitted and where not permitted
- Investigate and identify parking hubs/vehicle access on tracks / river trail
- How is traffic managed – physical barriers, signage, safety

SIGNAGE AND WAYFINDING

- Mix of different signage styles throughout the trail, lack of unifying features
- Current signage has minimal information on it, wayfinding may be difficult for those who don't know the area
- Signage provides an opportunity to provide much greater level of information relating to the trail and its surroundings, from facilities to history and cultural values
- Signage type, design & hierarchy No significant start/end signage
- Temporary signage requirements – e.g. signage required to warn of road flooding, toxic algal blooms

CONNECTIONS

- Establish better defined connections between the river corridor and the city centres
- Establish better connections between the river corridor and open spaces managed by HCC/UHCC

FURNITURE

- Seating, water fountains, picnic tables, shelters, toilets
- Development of palette of simple robust elements appropriate to receiving river corridor environment

PLANTING AND REVEGETATION

- Identify planting projects for each reach of the river corridor
- Development of species mixes for different areas/environments

WETLAND DEVELOPMENT

- Wetland development following pilot projects

VEGETATION MANAGEMENT

- Pest plant and animal species
- Pest plant control methods

WATER QUALITY

- Toxic algae
- Stormwater discharge
- Pollution

CULTURAL AND HISTORIC ASSOCIATIONS

- Recognise sites of significance to mana whenua and iwi association with specific parts of the river corridor (see page 72 for full list of Sites of Significance)
- QR codes and other digital devices provide modern interactive methods to assist communication and ways to tell stories

MANAGEMENT AND MAINTENANCE RESPONSIBILITY

- Identify organisations with jurisdiction over different assets along the river corridor
 - Outline of maintenance agreements exist
-



MANAGEMENT PRINCIPLES

Along with the identified river-wide issues, a number of management principles relating to access and activities in the river corridor have been established. These are outlined below.

VEHICLE ACCESS

Vehicle access to the river bed is an ongoing issue throughout the river corridor. Feedback from the community to GWRC, Hutt City and Upper Hutt City Councils is that unwanted behaviour along the river is having an adverse effect on people wanting to use all areas of the river and walkways. One aspect of the antisocial behaviour stems from people entering the river banks on motorised vehicles (cars and motorcycles). Unrestricted access also creates health and safety issues with the presence of unauthorised vehicles in a non-vehicle environment, dangerous driving behaviour and vehicle access associated issues with rubbish dumping.

The Options and Assessment Report for Barrier Designs Along the Hutt River Trails (2017) identifies that any barriers need to keep motorised vehicles out while still providing an aesthetically pleasing environment for people to enjoy. Barriers also still need to enable the passage of people and animals. Walkers, cyclists, runners, walkers and runners with prams, wheelchair users and people riding horses all need to be able to pass barriers that will keep vehicles and motorbikes out. The option assessment identifies three primary barrier options:

- multi access 'K' barriers
- cycle staple squeeze barriers
- lockable vehicle barriers where required.

The report also identifies other works in relation to carparking including trail head upgrades, car parks set back from river edge or in a position which prevents them from dominating the environment, which could be rewarded with car shade created by tree planting.

The Future of the Te Awa Kairangi/ Hutt River corridor seeks to establish parking "hubs" which would accommodate vehicle access and carparking within restricted areas of the river corridor. Restricting vehicle access to defined places/nodes will reduce the areas of conflict. Continuous vehicle access along the river berm will be for GWRC vehicles only.

Access points and routes will ideally avoid or minimise vehicle / cyclist / pedestrian conflicts. Safety improvements to vehicle entry and egress are also required in some locations.

EQUESTRIAN ACCESS

The stopbanks and sealed pathways of the River Trail are not suitable for equestrian access due to the potential for conflict between cyclists, walkers and horses, and potential for damage to the stopbank structures. Equestrian access is allowed on other parts of the trail. Equestrian facilities adjacent to the trail include the Belmont Pony Club at Belmont Doman and Riding for the Disabled at County Lane, Silverstream. Kaitoke

Regional Park, Pakuratahi Forest and Tunnel Gully Recreation area are other areas under the jurisdiction of GWRC which also provide equestrian access.

MOBILITY ACCESS

Greater Wellington has been upgrading tracks and other facilities since the late 1990s, to make parks and outdoor spaces accessible to a wider range of people. As a result, there are now several areas along the river that may be negotiated by people with limited mobility or in wheelchairs. Other tracks are suitable for disabled people with assistance. Toilets in GWRC parks are now almost all wheelchair accessible. The Te Awa Kairangi/ Hutt River trail provides easy access for people with limited mobility or in wheelchairs on the section from Kennedy Good Bridge to the Estuary Bridge on the true left bank. The sealed path runs under Melling Bridge, giving easy access to the carpark. There are several steeper grade ramps from the Riverbank car park to the Trail on top of the stopbank near Lower Hutt City centre.

Areas of flat trail with gravel surfacing may also be able to be accessed by some wheelchair users with assistance.

FREEDOM CAMPING

Greater Wellington does not support freedom camping within the river corridor.

Camping facilities should be created outside the floodway where they can be better managed without the risk of flooding. In the Hutt Valley, Greater Wellington provides camping areas at both Kaitoke and Belmont (Dry Creek) Regional Parks. In addition, camping is also provided at Battle Hill Farm Park. In all three locations campers can have the experience of being close to a stream which does not pose the same risk as the Te Awa Kairangi/ Hutt River plus there are basic facilities and a ranger service provided at each park.



RIVER KNOWLEDGE AND ASSETS

GWRC retains a wealth of knowledge and information on river use and assets within the corridor. *The Future of the Te Awa Kairangi/ Hutt River Corridor* is intended as a 'living' document, and using this data in a intelligent and integrated manner to inform the future development of the river corridor is an aim for the future of this document.

USER SURVEYS

The GWRC Te Awa Kairangi/ Hutt River Corridor User Survey (2016) surveyed 960 respondents on their views on the Te Awa Kairangi/ Hutt River. The data from this survey informed the preparation of the Te Awa Kairangi/ Hutt River Environmental Strategy.

Key points from the results were:

- Improving water quality in the Te Awa Kairangi/ Hutt River was considered the top priority management activity. More than double the number of respondents considered water quality a top priority for action compared with reducing the risk of flooding businesses and houses.
- Most respondents (60%) considered that the River corridor was better compared with when they first visited it, and 33% thought it had not changed. The longer a respondent's experience with the River corridor, the more likely they were to think that it had improved. 82% of respondents with more than 20 years of experience thought it was better.
- The level of conflict between users is low, with 4% of inter and intra-activity interactions being reported as negative, while 87% of interactions were reported as positive, yet there are vehicle and pedestrian conflicts.

As it is approaching five years since this survey was carried out, an updated survey which would begin to track changes and identify trends would be useful and perhaps repeated every 5-7 years.

ASSET DATA

Information on asset data in the river corridor is more limited, and complicated by the number of different bodies who maintain assets within the corridor, including Upper Hutt City Council, Hutt City Council, NZTA and Wellington Water. Beginning to establish a database of assets maintained by both GWRC and other parties will create a valuable tool for the asset maintenance team, and inform future development in the river corridor. Existing GIS data held by GWRC provides a starting point for this database.





WATER QUALITY

Improving water quality is a key underlying principle of the Future of the Te Awa Kairangi/ Hutt River corridor. A key objective of the Environmental Strategy was to restore, protect and enhance the river's mauri (life force). This objective recognises that Te Awa Kairangi/Te Awa Kairangi/ Hutt River is culturally and spiritually significant to mana whenua and that there needs to be a holistic approach to the health of the river. Healthy river - healthy mauri - healthy connections and relationships.

The Environmental Strategy identified a number of issues relating to water quality, which included:

- Reduced water quality and low summer flows degrading aquatic biodiversity and habitat. The aim should be to improve water quality and ensure that the quantity and flow of water is not reduced so as to adversely affect habitat and ecological values.
- Concerns relating to water quality, such as algal blooms, low summer flows and rubbish in the water were the most common (i.e. 'worst' issue raised in the 2016 Te Awa Kairangi/ Hutt River User Survey). Similarly, the highest priority for improvement concerned water quality to be achieved by better control of algae, bacteria and other pollutants, and rubbish/litter.
- Recognising the limit of what can be achieved within the river corridor with respect to catchment-scale issues. Groundwater with higher nitrate levels enters the river between Whakatikei River and Taita Gorge.
- There is poor recreational water quality (bacteriological) from Melling Bridge to Wellington Harbour. This relates to health risk from faecal contamination of water from disease-causing organisms caused by runoff from farmland, stormwater discharges, or large waterfowl populations.

- The reaches from Melling Bridges to the harbour and the estuary have tidal and saline influences and these should be recognised in biodiversity enhancement opportunities.
- Toxic algae (cyanobacteria) impacts on recreational use of the river in summer and can exceed national guideline levels during summer months. It is most problematic between Barton's Bush and Melling Bridge.
- Numerous stormwater outlets discharge directly to the river without any treatment. There are opportunities to improve the water quality of the stormwater before it reaches the river through the construction of detention ponds/wetlands where space allows on the river berms.

The section below outlines the relevant plans and policy document which relate to water quality in the Te Awa Kairangi/ Hutt River.

NPS FOR FRESHWATER

The National Policy Statement for Freshwater Management 2020 (Freshwater NPS) provides local authorities with direction on how to manage freshwater under the Resource Management Act 1991.

Requirements of the Freshwater NPS include:

- Manage freshwater in a way that 'gives effect' to Te Mana o te Wai:
 - through involving tangata whenua
 - working with tangata whenua and communities to set out long-term visions in the regional policy statement
 - prioritising the health and wellbeing of water bodies, then the essential needs of people, followed by other uses.
- Improve degraded water bodies, and maintain or improve all others using bottom lines defined in the Freshwater NPS.

- An expanded national objectives framework:
 - two additional values - threatened species and mahinga kai - join ecosystem health and human health for recreation, as compulsory values
 - councils must develop plan objectives that describe the environmental outcome sought for all values (including an objective for each of the five individual components of ecosystem health)
 - new attributes, aimed specifically at providing for ecosystem health, include fish index of biotic integrity (IBI), sediment, macroinvertebrates (MCI and QMCI), dissolved oxygen, ecosystem metabolism and submerged plants in lakes; councils will have to develop action plans and/or set limits on resource use to achieve these attributes.
 - tougher national bottom lines for the ammonia and nitrate toxicity attributes to protect 95% of species from toxic effects (up from 80%)
- Avoid any further loss or degradation of wetlands and streams, map existing wetlands and encourage their restoration.
- Identify and work towards target outcomes for fish abundance, diversity and passage and address in-stream barriers to fish passage over time.
- Set an aquatic life objective for fish and address in-stream barriers to fish passage over time.
- Monitor and report annually on freshwater (including the data used); publish a synthesis report every five years containing a single ecosystem health score and respond to any deterioration.

ENVIRONMENTAL CODE OF PRACTICE AND MONITORING PLAN

Environmental Code of Practice (The Code) directs how all flood protection and erosion control activities across the region are carried out, irrespective of funding, location and whether an activity requires resource consent or not (i.e. it applies to permitted activities as well as those activities for which resource consent is required under the regional plans). The Environmental Monitoring Plan (EMP) is included in the Code and outlines the monitoring that GWRC will do of these activities to allow practice to be adapted should this monitoring show that unexpected or significant effects on values are occurring. The Code sits alongside the Te Awa Kairangi/ Hutt River Floodplain Management Plan.

TOXIC ALGAE

Toxic algae has been a major concern for river users since five dogs died after coming into contact with the algae in the river, just over ten years ago. As a large gravel bed river, the Te Awa Kairangi/ Hutt River is prone to toxic algae. The Te Awa Kairangi/ Hutt River also has low concentrations of phosphorus and moderate concentrations of nitrogen, which is consistent with other rivers across the region and New Zealand where toxic algal blooms are a problem.

The most widespread bloom-forming type of toxic algae is called *Phormidium* spp. It commonly forms thick leathery black/brown mats across large areas of the river or stream bed. Some species of *Phormidium* produce toxins, including several kinds of neurotoxins (which affect the nervous system). If swallowed these toxins can cause vomiting, diarrhoea and severe abdominal pain. Dogs are particularly at risk because they love the musty odour of toxic algae and will eat it.

Contrary to popular belief, the presence of toxic algae does not necessarily indicate poor water quality. Assessment of water column nutrient data suggests that *Phormidium* blooms occur under a range of nitrogen concentrations, but generally only occur in rivers with low phosphorus levels.

Nitrogen concentrations increase over ten fold between Kaitoke (where toxic algal blooms are rare) to Silverstream Bridge (where toxic algal blooms are the most prolific).

The Pakuratahi and Mangaroa Rivers are the biggest surface water contribution of nitrogen to the Te Awa Kairangi/ Hutt River. Surface water from these rivers, along with the Whakatikei and Akatarawa rivers, and the upper reaches of the Te Awa Kairangi/ Hutt River, contribute around 60% of the total nitrogen load.

Investigations show that the other major source of nitrogen is groundwater upwelling into the river between the Whakatikei and Taita Gorge. The groundwater entering this part of the river comes from the aquifer that lies under the urban area of Upper Hutt City. The sources of nitrogen are unclear but are likely to be fertiliser used on parks, gardens and golf courses, and leaky sewer pipes. Age dating of water samples reveals this groundwater is relatively young, approximately 2-3 years. This suggests

that the results of any management actions to reduce nitrogen in the groundwater are likely to be realised within a relatively short time.

Currently, an online interactive map which is updated regularly during the summer season when algal blooms reach its peak, provides warnings to the public about sites which are affected by toxic algae. There is however no current temporary warning signage at such locations and this should be provided.













PROJECT ACTIONS

SHORT: ***

MEDIUM: **

LONG: *

		ESTUARY TO EWEN	EWEN TO KENNEDY GOOD	KENNEDY GOOD TO POMARE	POMARE TO SILVERSTREAM	SILVERSTREAM TO MOONSHINE	MOONSHINE TO TOTARA PARK	TOTARA PARK TO BIRCHVILLE	BIRCHVILLE TO TE MARUA
	TRAILS AND SURFACING	Trail improvements	**	**	**	**	**	***	
		New trail link	**			***	**		**
	TRAFFIC MANAGEMENT	Parking hubs	**	**	**	**	**	**	**
		Traffic control required	*	*					
	SIGNAGE AND WAYFINDING	Start and end trail signage	*						*
		Directional, interpretation and information signage	**	**	**				
	CONNECTIONS	Develop connections to City Centre		***			**		
		Develop connections to other open space				*	*	**	**
	FURNITURE AND FACILITIES	Area with enhanced facilities	**	***	**	*	**		
		Public toilets		*			*		
	PLANTING AND REVEGETATION	Planting project with indigenous species	**	**	*	**	**	***	***
		'Parkland' planting with exotic species	**		**				
	WETLAND DEVELOPMENT	Wetland development			*	**	**	*	
		Estaurine wetland development	*						
	VEGETATION MANAGEMENT	Pest plant management required							
	CULTURAL AND HISTORIC ASSOCIATIONS	Recognise sites of significance to mana whenua	**	**	**				
		Interpretation		*					

		ESTUARY TO EWEN	EWEN TO KENNEDY GOOD	KENNEDY GOOD TO POMARE	POMARE TO SILVERSTREAM	SILVERSTREAM TO MOONSHINE	MOONSHINE TO TOTARA PARK	TOTARA PARK TO BIRCHVILLE	BIRCHVILLE TO TE MARUA
 MANAGEMENT AND MAINTENANCE RESPONSIBILITIES	Existing maintenance agreement				**				
	Work with existing groups				*	*			
 WATER QUALITY	Toxic algae		**			**			

AREA SPECIFIC ACTIONS



ESTUARY TO EWEN

ISSUES AND ACTIONS

The Waione Street Bridge is a very popular location for fishing, however, conflicts for space arise due to the inadequate width of the bridge footpath to accommodate pedestrians and cyclists, and people fishing. There are no safe parking or toilet facilities in what is a high use recreational area around Waione Bridge.

TRAILS AND SURFACING

- Assess options to widen pedestrian/cycle path on Waione Bridge (or alternative means to provide for multiple use).
- Enhance aesthetics and walkway around Sand Plant point.
- Upgrade links under and on to Ava Rail Bridge and Shandon Golf Course.

TRAFFIC MANAGEMENT

- Formalise carparking on west end of Waione Bridge for fishers and cycleway users.

SIGNAGE AND WAYFINDING

- Instructional signs for sharing the bridge, directional signs to the Hutt River Trail start

CONNECTIONS

- Link to the Sand Point, Sladden and Strand Parks

FURNITURE AND FACILITIES

- Improve facilities at Waione Bridge for recreational users (e.g. clip on bridge for fishers)
- The reach is a well-used corridor for both recreational users and commuters and would benefit from enhancements and facilities to improve the amenity and overall quality of the area.
- The hard fill armour between the Waione St Bridge and Seaview Marina has an unattractive and brutal appearance. Opportunity to enhance recreational benefits when this is upgraded.
- Provide facilities in Sladden and Strand Parks to support high use area for nearby residents and visitors, such as seats, picnic tables.

PLANTING AND REVEGETATION

- Opportunities to enhance habitat associated with the saltwater and tidal influences should be a key focus for this reach.
- Planting in this reach should be indigenous species to support the current character and enhance the ecological values, particularly close to the river.
- Prioritise river riparian planting to enhance inanga spawning habitat where appropriate.
- Develop a more 'park land' character in Strand Park with a more structured tree framework to provide shelter and shade and add diversity to the space. Plant groups of indigenous trees in open parts of the park and along the toe of the stopbank in the Park.
- Plant groups of indigenous trees in open parts of the park and along the toe of the stopbank in the Park.
- Channel realignment at old woollen mill site – opportunity to plant when channel is realigned

WETLAND DEVELOPMENT

VEGETATION MANAGEMENT

- Establish management regime for proposed new planting

CULTURAL AND HISTORIC ASSOCIATIONS

- Identify opportunities to recognise and support the identified mana whenua values of this reach as targeted projects or integrated with other development works.

MANAGEMENT AND MAINTENANCE RESPONSIBILITY



PROJECT AREAS

WAIONE STREET BRIDGE

KEY

- 1 Assess options to widen pedestrian/cycle path (e.g. clip ons)
- 2 Upgrade link to golf course
- 3 Formalise carparking
- 4 Improve facilities (e.g. public toilets)
- 5 Enhance habitat with saltwater and tidal influences
- 6 Develop new walkway on the west side of Te Mome Stream
- 7 Identify opportunities to recognise and support mana whenua values of this reach as targeted projects or integrated with development works
- 8 Develop instructional signs (i.e. sharing the bridge) and directional signage to Hutt River trail start/city

LEGEND

- | | | | |
|--|-------------------------------------|--|----------------------------|
| | RIVER INFORMATION SIGN | | EXISTING TOILET FACILITIES |
| | RIVER DIRECTIONAL SIGN | | SWIMMING HOLE |
| | RIVER CULTURAL/ INTERPRETATION SIGN | | HORSE RIDING AREA |
| | PARKING HUB | | |

KEY TO PROJECTS

- | | | | |
|--|----------------------------|--|------------------------------------|
| | TRAILS AND SURFACING | | VEGETATION MANAGEMENT |
| | TRAFFIC MANAGEMENT | | WETLAND DEVELOPMENT |
| | SIGNAGE | | CULTURAL |
| | CONNECTIONS | | PROPOSED PLANTING AND REVEGETATION |
| | MANAGEMENT AND MAINTENANCE | | WATER QUALITY |
| | FURNITURE AND FACILITIES | | |



WAIONE STREET | FUTURE OF THE TE AWA KAIRANGI/ TE AWA KAIRANGI/ HUTT RIVER CORRIDOR | MARCH 2022



PROJECT AREAS

STRAND PARK AND AVA PARK

KEY

- 1 Upgrade facilities in Strand Park and Sladden Park
- 2 Create more 'park like' planting and features in Strand Park. Plant groups of trees in open parts of the park and along the toe of the stopbank in the Park
- 3 Upgrade links under and on to Ava Rail Bridge
- 4 Identify opportunities to recognise and support mana whenua values of this reach as targeted projects or integrated with development works

LEGEND

- | | | | |
|--|-------------------------------------|--|----------------------------|
| | RIVER INFORMATION SIGN | | EXISTING TOILET FACILITIES |
| | RIVER DIRECTIONAL SIGN | | SWIMMING HOLE |
| | RIVER CULTURAL/ INTERPRETATION SIGN | | HORSE RIDING AREA |
| | PARKING HUB | | |

KEY TO PROJECTS

- | | | | |
|--|----------------------------|--|------------------------------------|
| | TRAILS AND SURFACING | | VEGETATION MANAGEMENT |
| | TRAFFIC MANAGEMENT | | WETLAND DEVELOPMENT |
| | SIGNAGE | | CULTURAL |
| | CONNECTIONS | | PROPOSED PLANTING AND REVEGETATION |
| | MANAGEMENT AND MAINTENANCE | | WATER QUALITY |
| | FURNITURE AND FACILITIES | | |

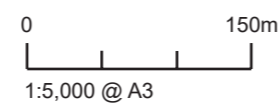

STRAND PARK AND AVA PARK | TE AWA KAIRANGI/ HUTT RIVER CORRIDOR | MARCH 2022



EWEN TO KENNEDY GOOD

ISSUES AND ACTIONS

The reach extends 3.7km between the Ewen and Kennedy-Good Bridges and passes through the Hutt City CBD and as such is the most urban and developed of the reaches. The whole reach is being considered as part of the RiverLink Project, as such the actions for this reach are encompassed in the implementation of the RiverLink development works.

TRAILS AND SURFACING

- Provide a broad high-amenity walkway along the stop bank between Ewen and Melling bridges (HCC CCTP)

TRAFFIC MANAGEMENT

- Being resolved as part of comprehensive Riverlink project

SIGNAGE AND WAYFINDING

CONNECTIONS

- The RiverLink project is a comprehensive multi-agency development to improve flood protection, transport linkages, and the Hutt CBD's relationship to the river and the potential recreation opportunities it provides and which could be further developed.
- Introduce a network of minor streets and lanes including east-west connections that open up the core central city to the river (HCC CCTP)
- Provide east-west connections linking the central city core to the river and beyond, over the river to Alicetown, Melling and the Western Hills (HCC CCTP)

FURNITURE AND FACILITIES

- Being resolved as part of comprehensive Riverlink project

PLANTING AND REVEGETATION

- Being resolved as part of comprehensive Riverlink project

WETLAND DEVELOPMENT

- Wetlands to be developed as a part of the Riverlink project

VEGETATION MANAGEMENT

CULTURAL AND HISTORIC ASSOCIATIONS

- Acknowledge Motutawa Pā site
- Acknowledge Makaenuku Pā site as a site of significance to Ngāti Toa

MANAGEMENT AND MAINTENANCE RESPONSIBILITY



PROJECT AREAS

TIROHANGA WETLAND











KEY

- 1 Proposed wetland area as a part of the Riverlink project
- 2 Acknowledge Motutawa Pā site
- 3 Acknowledge Makaenuku Pā site

LEGEND

- | | | | |
|---|-------------------------------------|---|----------------------------|
|  | RIVER INFORMATION SIGN |  | EXISTING TOILET FACILITIES |
|  | RIVER DIRECTIONAL SIGN |  | SWIMMING HOLE |
|  | RIVER CULTURAL/ INTERPRETATION SIGN |  | HORSE RIDING AREA |
|  | PARKING HUB | | |

KEY TO PROJECTS

- | | | | |
|---|----------------------------|---|------------------------------------|
|  | TRAILS AND SURFACING |  | VEGETATION MANAGEMENT |
|  | TRAFFIC MANAGEMENT |  | WETLAND DEVELOPMENT |
|  | SIGNAGE |  | CULTURAL |
|  | CONNECTIONS |  | PROPOSED PLANTING AND REVEGETATION |
|  | MANAGEMENT AND MAINTENANCE |  | WATER QUALITY |
|  | FURNITURE AND FACILITIES | | |



0 250m
1:7,500 @ A3

TIROHANGA WETLAND | FUTURE OF THE TE AWA KAIRANGI/ HUTT RIVER CORRIDOR | MARCH 2022



KENNEDY GOOD TO POMARE RAIL BRIDGE

ISSUES AND ACTIONS

The reach is well used for a variety of recreational activities, particularly swimming during summer months, being close to the residential areas of Hutt City. Parts of the reach also suffer anti-social issues such as fly tipping and unsafe vehicle use. Popular destination for swimming (eg Taita Rock).

There are good opportunities to upgrade and enhance the berm area that adjoins the Taita community (between chainage 850 and Pomare Rail Bridge). Improving the quality and functionality of the area will create a more attractive destination, encourage more people to spend more time there and reduce the anti-social behaviours. The area could be identified and branded as a 'riverpark' and the process of its upgrade can be used as a vehicle to gain community ownership and knowledge of this reach of the river corridor.

TRAILS AND SURFACING

- Identify opportunities / methods to improve connections over the stopbank to Taita Drive.
- Enhance visual and physical access to river groynes for fishing/swimming.

TRAFFIC MANAGEMENT

- Enhance north and south vehicle entrances to the area to make them more defined, attractive and safe.
- Rationalise traffic flows and carparks to, seal vehicle access, restrict or stop through traffic, add carparking, and restrict vehicle access to the river bed.
- Provide a separate cycle/walkway to vehicle access.
- Relocate stockpiles away from carpark area at Taita Rock.
- Physical barriers to stop vehicle entering river
- Develop carpark at Percy Cameron Street, restricting vehicle access to the berm outside this area

SIGNAGE AND WAYFINDING

- Identify opportunities / methods to improve connections over the stopbank to Taita Drive.
- Improve link from river/ rail trail to Avalon Park with better crossings and signage.
- Enhance visual and physical access to river groynes for fishing/swimming.

CONNECTIONS

- Develop safe pedestrian access from the stopbank at Percy Cameron St to the riverside trail

FURNITURE AND FACILITIES

- Upgrade the area to create a 'park' with its own name and identity. Improve the quality of the area
- Provide and improve visitor facilities – toilets, picnic tables, shade trees, play equipment

PLANTING AND REVEGETATION

- Enhance existing planting

WETLAND DEVELOPMENT

- Investigate/construct detention basins/wetlands at stormwater outfall points.

VEGETATION MANAGEMENT

- Control of blackberry required?

CULTURAL AND HISTORIC ASSOCIATIONS

MANAGEMENT AND MAINTENANCE RESPONSIBILITY

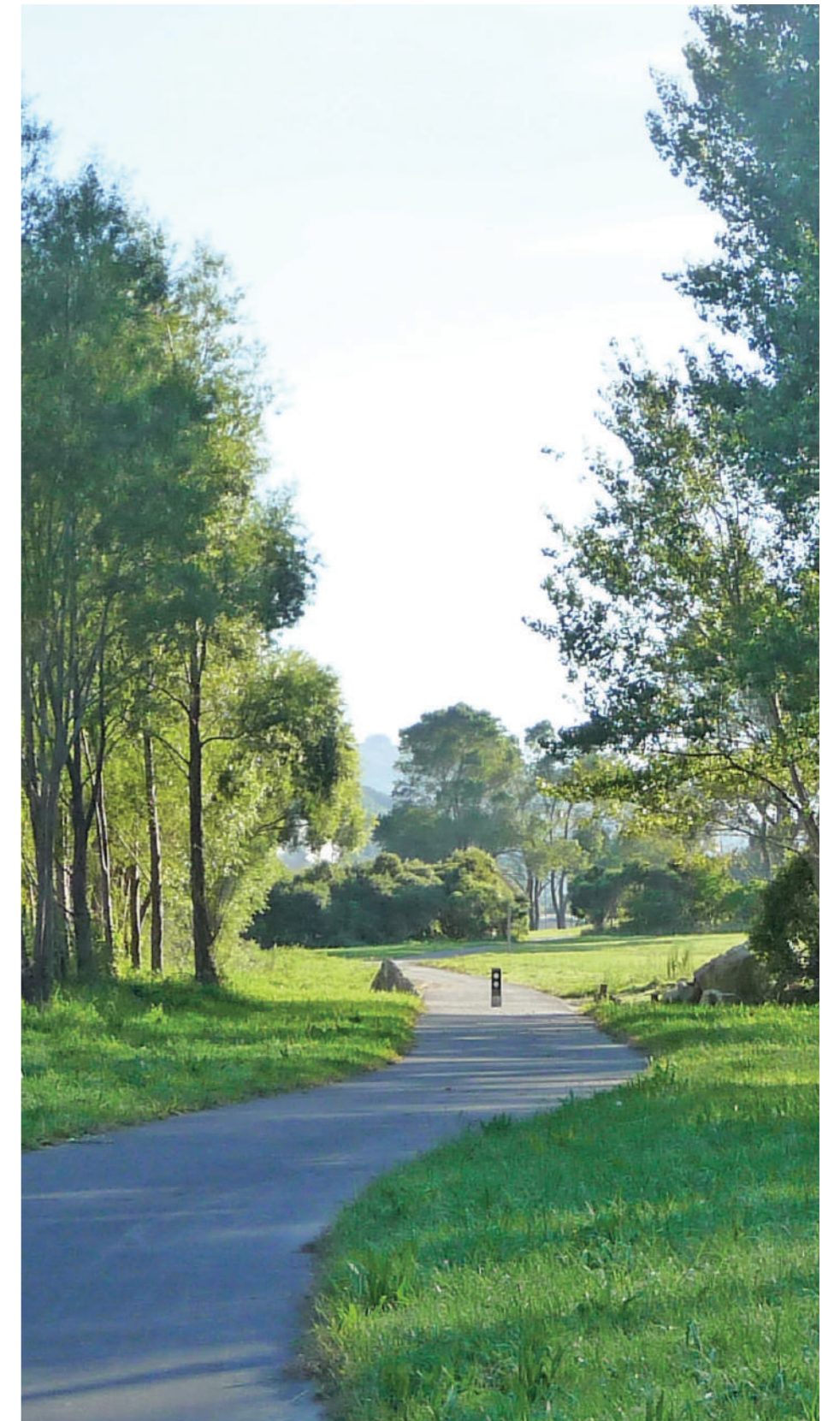

PROJECT AREAS

BELMONT/AVALON

KEY

- 1 Improve link from river trail to Avalon Park with better crossings and signage at the existing crossing point near Kennedy Good Bridge
- 2 Enhance visual and physical access to river groynes for fishing/swimming by removing sections of willow and creating tracks
- 3 Investigate stormwater detention basins/wetlands at outfall points
- 4 Develop carpark at Percy Cameron Street, restricting vehicle access to the berm outside this area
- 5 Develop safe pedestrian access from the stopbank at Percy Cameron St to the riverside trail

LEGEND

- | | | | |
|--|-------------------------------------|--|----------------------------|
| | RIVER INFORMATION SIGN | | EXISTING TOILET FACILITIES |
| | RIVER DIRECTIONAL SIGN | | SWIMMING HOLE |
| | RIVER CULTURAL/ INTERPRETATION SIGN | | HORSE RIDING AREA |
| | PARKING HUB | | |

KEY TO PROJECTS

- | | | | |
|--|----------------------------|--|------------------------------------|
| | TRAILS AND SURFACING | | VEGETATION MANAGEMENT |
| | TRAFFIC MANAGEMENT | | WETLAND DEVELOPMENT |
| | SIGNAGE | | CULTURAL |
| | CONNECTIONS | | PROPOSED PLANTING AND REVEGETATION |
| | MANAGEMENT AND MAINTENANCE | | WATER QUALITY |
| | FURNITURE AND FACILITIES | | |



BELMONT/AVALON | FUTURE OF THE TE AWA KAIRANGI/ HUTT RIVER CORRIDOR | MARCH 2022



PROJECT AREAS

TAITA ROCK











KEY

- 1 Improve connections over the stopbank by creating new cycling and walking links opposite walkway/street junctions
- 2 Enhance access for fishing and swimming by creating new pedestrian path and views towards river/swimming hole
- 3 Improve vehicle access by improving access across the stopbank leading to parking hub(s) in this area. Vehicle tracks beyond parking hub to be restricted for maintenance use.
- 4 Restrict access to the river bed by vehicles with the creation of the parking hub and pedestrian paths. Remove opportunities to access the riverbed by vehicle and restrict those remaining for maintenance use only.
- 5 Enhance existing planting with groups of trees planted for shade and shelter
- 6 Improve facilities by providing seating/picnic tables in newly created sheltered areas
- 7 Provide a separate cycleway to vehicle access
- 8 Investigate/construct stormwater retention basins at outfalls

LEGEND

- | | |
|--|--|
|  RIVER INFORMATION SIGN |  EXISTING TOILET FACILITIES |
|  RIVER DIRECTIONAL SIGN |  SWIMMING HOLE |
|  RIVER CULTURAL/INTERPRETATION SIGN |  HORSE RIDING AREA |
|  PARKING HUB | |

KEY TO PROJECTS

- | | |
|--|--|
|  TRAILS AND SURFACING |  VEGETATION MANAGEMENT |
|  TRAFFIC MANAGEMENT |  WETLAND DEVELOPMENT |
|  SIGNAGE |  CULTURAL |
|  CONNECTIONS |  PROPOSED PLANTING AND REVEGETATION |
|  MANAGEMENT AND MAINTENANCE |  WATER QUALITY |
|  FURNITURE AND FACILITIES | |



0 60m
1:2,000 @ A3

TAITA ROCK | FUTURE OF THE TE AWA KAIRANGI/ HUTT RIVER CORRIDOR | MARCH 2022



POMARE TO SILVERSTREAM

ISSUES AND ACTIONS

This reach extends 3.0km between the Pomare Rail Bridge and the Silverstream Rail and Road Bridges. This narrow section of the river corridor is known as the Taita Gorge, where the Belmont and Stokes Valley hills constrict the river flood plain and create a contrasting character to the wider river plains to the north and south.

The narrow river corridor in the gorge area offers the opportunity to enhance the ecological corridor across the river between the indigenous forest located on both sides of the river. Additional planting of indigenous vegetation to further enclose the river corridor, particularly the open grassed area will create a contrasting experience for river trail users, giving the reach a more 'wild' and 'bush' aesthetic.

TRAILS AND SURFACING

- Identify opportunity to provide pedestrian/cycle access across Pomare Rail Bridge.
- Manor Park Golf Course walkway extensions - River Trail to be extended along stopbanks and under the Silverstream Bridges to complete the trail on the western side of the river. Work with the Manor Park Golf Club.

TRAFFIC MANAGEMENT

- Define carparking areas

SIGNAGE AND WAYFINDING

- Use interpretative signage to highlight connections between the river corridor and Belmont Regional Park and Keith George Memorial Park

CONNECTIONS

- With future urban intensification an opportunity is to improve walking and cycling access to the Te Awa Kairangi/ Hutt River Trail. (UHCC OSS)

FURNITURE AND FACILITIES

- Maintain and enhance Silverstream Bridges area as a recreation destination.
- Construct a separate river trail bridge across Hulls Creek.

PLANTING AND REVEGETATION

- Cross river ecological corridor enhancement, enhance the amenity and aesthetic to one of more 'wild, enclosed bushland'.
- Consider opportunities to improve the ecological function and values of the Stokes Valley Stream channel.

WETLAND DEVELOPMENT

- Sewer weir requires maintenance of fish passage structures.

VEGETATION MANAGEMENT

CULTURAL AND HISTORIC ASSOCIATIONS

MANAGEMENT AND MAINTENANCE RESPONSIBILITY

- Work with groups who are restoring the Hulls Creek habitat.- Forest and Bird Silverstream Care Group have a long commitment to enhancement of the riparian margins, particularly upstream of the river berm.



PROJECT AREAS

MANOR PARK/POMARE

KEY

- 1 Identify opportunities to provide pedestrian/cycle access across Pomare Rail Bridge
- 2 Enhance the amenity and aesthetic of this area to one of more 'wild, enclosed bushland' through strategic planting.
- 3 Use interpretative signage to highlight connections between the river corridor and Belmont Regional Park.
- 4 Extend the river trail along the stopbanks to complete the trail through the Manor Park Golf Course on this side of the river
- 5 Improve the ecological and aesthetic function of Stokes Valley Stream through planting and enhanced fish passage at the stream outlet into the river.

LEGEND

- | | | | |
|--|-------------------------------------|--|----------------------------|
| | RIVER INFORMATION SIGN | | EXISTING TOILET FACILITIES |
| | RIVER DIRECTIONAL SIGN | | SWIMMING HOLE |
| | RIVER CULTURAL/ INTERPRETATION SIGN | | HORSE RIDING AREA |
| | PARKING HUB | | |

LEGEND

- | | | | |
|--|-------------------------------------|--|------------------------------------|
| | RIVER INFORMATION SIGN | | VEGETATION MANAGEMENT |
| | RIVER DIRECTIONAL SIGN | | WETLAND DEVELOPMENT |
| | RIVER CULTURAL/ INTERPRETATION SIGN | | CULTURAL |
| | PARKING HUB | | PROPOSED PLANTING AND REVEGETATION |
| | MANAGEMENT AND MAINTENANCE | | WATER QUALITY |
| | FURNITURE AND FACILITIES | | |



0 250m
1:7,500 @ A3

POMARE/MANOR PARK | FUTURE OF THE TE AWA KAIRANGI/ HUTU RIVER CORRIDOR | MARCH 2022









PROJECT AREAS

MANOR PARK NORTH











KEY

- 1 Use interpretative signage to highlight connections between the river corridor and Keith George Memorial Park.
- 2 Enhance Silverstream bridges as a recreational facility through improved carpark and toilet facilities.
- 3 Extend the river trail along the stopbanks to complete the trail through the Manor Park Golf Course on this side of the river.
- 4 Maintain fish passage structures on sewer weir.
- 5 Construct a separate river trail bridge across Hulls Creek
- 6 Work with groups to enhance Hulls Creek habitat with enhanced riparian margins.

LEGEND

- | | |
|---|--|
|  RIVER INFORMATION SIGN |  EXISTING TOILET FACILITIES |
|  RIVER DIRECTIONAL SIGN |  SWIMMING HOLE |
|  RIVER CULTURAL/ INTERPRETATION SIGN |  HORSE RIDING AREA |
|  PARKING HUB | |

KEY TO PROJECTS

- | | |
|--|--|
|  TRAILS AND SURFACING |  VEGETATION MANAGEMENT |
|  TRAFFIC MANAGEMENT |  WETLAND DEVELOPMENT |
|  SIGNAGE |  CULTURAL |
|  CONNECTIONS |  PROPOSED PLANTING AND REVEGETATION |
|  MANAGEMENT AND MAINTENANCE |  WATER QUALITY |
|  FURNITURE AND FACILITIES | |



MANOR PARK NORTH | FUTURE OF THE TE AWA KAIRANGI/ HUTT RIVER CORRIDOR | MARCH 2022



SILVERSTREAM TO MOONSHINE

ISSUES AND ACTIONS

This reach extends 4.2km between the Silverstream Bridges and the Moonshine Bridge, and is characterised by its close proximity to the densely vegetated and undeveloped Wellington Fault scarp, but separated from it by SH2.

The close proximity of indigenous vegetation growing along the western escarpment offers the opportunity to enhance the ecological corridor across the river and the valley between the fault escarpment and Belmont Hills to Barton's Bush and beyond. Additional planting of indigenous vegetation will increase the biodiversity within this reach of the river corridor and continue the indigenous focus of the adjoining Pomare/Silverstream reach.

Parts of the western river berm are very damp, especially during winter. This is a potential location to establish wetland planting in place of mown grass, which long term could be developed into a lowland podocarp forest, a vegetation community that was once dominant in the river flood plain.

TRAILS AND SURFACING

TRAFFIC MANAGEMENT

- Improve vehicle control on true right bank - Area becomes very wet in winter attracting 4WD traffic along the berms. Rationalise vehicle use and consider need for carparks, through traffic, and access on/off SH2.
-

SIGNAGE AND WAYFINDING

CONNECTIONS

FURNITURE AND FACILITIES

PLANTING AND REVEGETATION

- Enhance cross river ecology through focusing on planting of indigenous species.
 - Where practicable, plant river edge with native species to enhance fish habitat.
 - Retain unplanted river margins where they exist
 - Heretaunga - The green corridor along the Te Awa Kairangi/ Te Awa Kairangi/ Hutt River links the reserves into a contiguous recreation esplanade with river access and walk and cycleway facilities. The river corridor also creates greater opportunities to enhance biodiversity values. (UHC OSS)
 - Opportunities / potential for an ecological corridor connecting to Moehau Park and the Te Awa Kairangi/ Te Awa Kairangi/ Hutt River corridor (UHCC OSS)
 - Establishing podocarp forest areas to re-introduce once extensive vegetation types in the river corridor.
-

WETLAND DEVELOPMENT

- Establish new wetland areas in the damper location on the west berm.
-

VEGETATION MANAGEMENT

- Toxic algae most problematic between Barton's Bush and Melling.
-

CULTURAL AND HISTORIC ASSOCIATIONS

MANAGEMENT AND MAINTENANCE RESPONSIBILITY

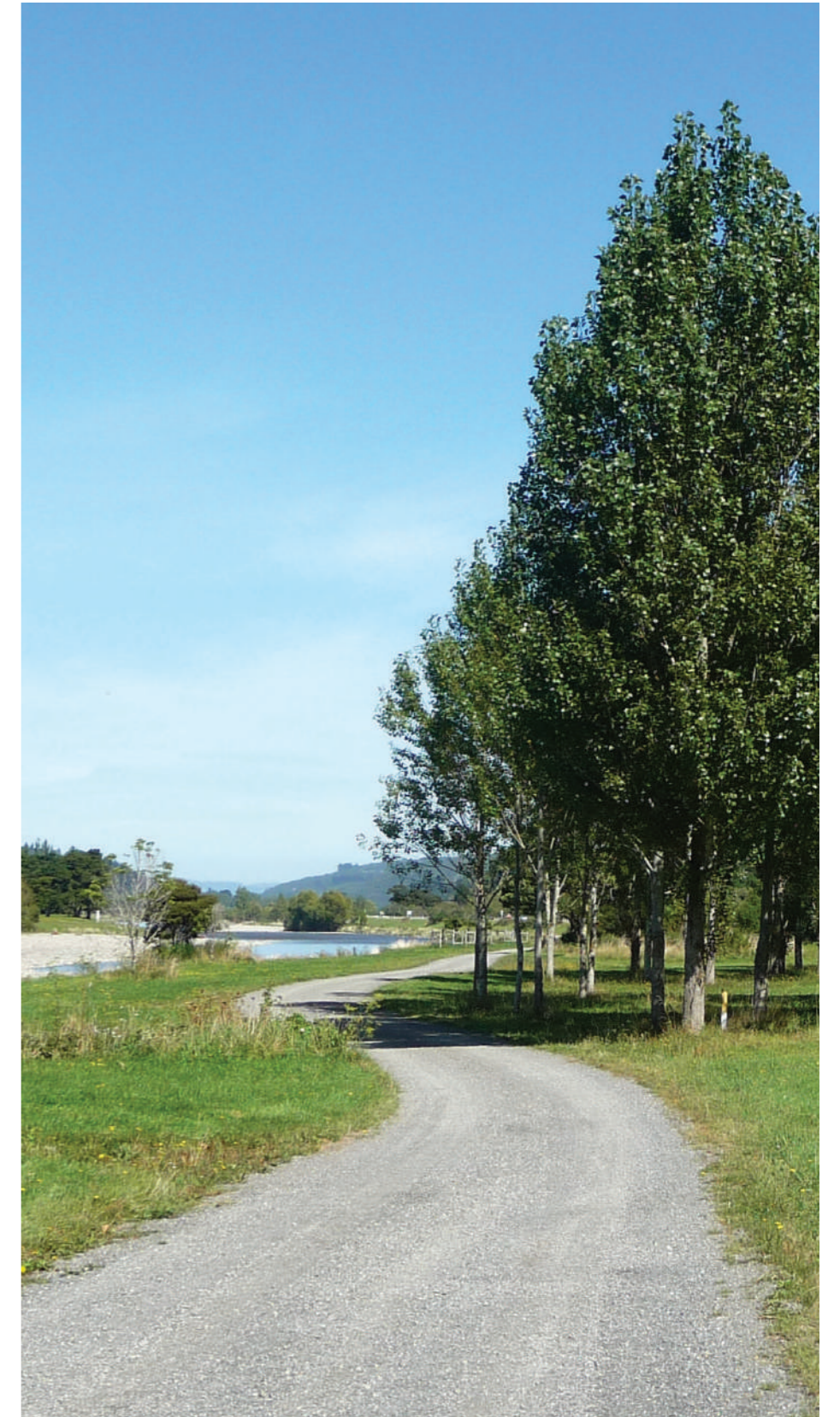







PROJECT AREAS

SILVERSTREAM











KEY

- 1 Enhance cross river ecology by planting indigenous species.
- 2 Improve vehicle control on true right bank.
- 3 Retain unplanted river margins where they exist.
- 4 Toxic algae is most problematic between Barton's Bush and Melling. Investigate temporary warning signage.

LEGEND

- | | |
|---|--|
|  RIVER INFORMATION SIGN |  EXISTING TOILET FACILITIES |
|  RIVER DIRECTIONAL SIGN |  SWIMMING HOLE |
|  RIVER CULTURAL/ INTERPRETATION SIGN |  HORSE RIDING AREA |
|  PARKING HUB | |

KEY TO PROJECTS

- | | |
|--|--|
|  TRAILS AND SURFACING |  VEGETATION MANAGEMENT |
|  TRAFFIC MANAGEMENT |  WETLAND DEVELOPMENT |
|  SIGNAGE |  CULTURAL |
|  CONNECTIONS |  PROPOSED PLANTING AND REVEGETATION |
|  MANAGEMENT AND MAINTENANCE |  WATER QUALITY |
|  FURNITURE AND FACILITIES | |



0 60m
1:2,000 @ A3

SILVERSTREAM | FUTURE OF THE TE AWA KAIRANGI/ HUTT RIVER CORRIDOR | MARCH 2022









PROJECT AREAS

TRENTHAM











KEY

- 1 Improve vehicle control on true right bank, by improving vehicle parking area and restricting access to vehicle tracks for maintenance.
- 2 Enhance cross river ecology by planting indigenous species.
- 3 Where practicable, plant river edge with low growing riparian vegetation (e.g. Carex spp. and sedges) to enhance fish habitat.
- 4 Establish new wetland areas in damper locations on the west berm which in the long term could develop into low podocarp forest.
- 5 Toxic algae is most problematic between Barton's Bush and Melling. Investigate temporary warning signage.

LEGEND

- | | |
|---|--|
|  RIVER INFORMATION SIGN |  EXISTING TOILET FACILITIES |
|  RIVER DIRECTIONAL SIGN |  SWIMMING HOLE |
|  RIVER CULTURAL/ INTERPRETATION SIGN |  HORSE RIDING AREA |
|  PARKING HUB | |

KEY TO PROJECTS

- | | |
|--|--|
|  TRAILS AND SURFACING |  VEGETATION MANAGEMENT |
|  TRAFFIC MANAGEMENT |  WETLAND DEVELOPMENT |
|  SIGNAGE |  CULTURAL |
|  CONNECTIONS |  PROPOSED PLANTING AND REVEGETATION |
|  MANAGEMENT AND MAINTENANCE |  WATER QUALITY |
|  FURNITURE AND FACILITIES | |



0 60m
1:2,000 @ A3

TRENTHAM | FUTURE OF THE TE AWA KAIRANGI/ HUTT RIVER CORRIDOR | MARCH 2022



MOONSHINE TO TOTARA PARK

ISSUES AND ACTIONS

This Reach extends 4.1km between the Moonshine and Totara Park Bridges, and is a popular and well used open space being in close proximity to the population of Upper Hutt City.

There is opportunity to improve and enhance the recreational amenity and facilities in this popular area, in particular, the berm between Poets Park and the Whakatikei carpark, and the large area inside the river bend.

TRAILS AND SURFACING

- Upgrade section of the river trail north of Whakatikei carpark.

TRAFFIC MANAGEMENT

SIGNAGE AND WAYFINDING

- Poets Block – Whakatiki Buffer reserve could potentially provide a link to stop bank shared pathway – no current links from Poets Block suburb to River (UHCC OSS)
- An opportunity exists within the open space at Riverbank Park to enhance the arrival and connectivity to the Upper Hutt city centre. This could be complemented by improved access to the Te Awa Kairangi/ Te Awa Kairangi/ Hutt River (UHCC OSS)

CONNECTIONS

FURNITURE AND FACILITIES

- Maintain and enhance Poets Park to Whakatikei carpark as a high use recreation destination.

PLANTING AND REVEGETATION

- Indigenous species should be the focus for planting in the river corridor.
- Develop new wetland/ lowland podocarp forest in 'horse paddock' on True Right Bank.

WETLAND DEVELOPMENT

VEGETATION MANAGEMENT

CULTURAL AND HISTORIC ASSOCIATIONS

MANAGEMENT AND MAINTENANCE RESPONSIBILITY



PROJECT AREAS

POETS PARK

KEY

- 1 Maintain and enhance Poets Park to Whakatikei carpark as a high use recreation destination, by developing toilet block and shelter with drinking fountain for people and dogs
- 2 Plant indigenous species to enrich to indigenous biodiversity and well as provide ecological benefits
- 3 Plant upgraded section of the river corridor north of Whakatikei carpark with indigenous trees.
- 4 Whakatiki Buffer reserve could potentially provide a link to stop bank shared pathway – no current links from Poets Block suburb to River (UHCC OSS).
- 5 Upgrade section of the river trail north of Whakatikei carpark.

LEGEND

- | | | | |
|--|-------------------------------------|--|----------------------------|
| | RIVER INFORMATION SIGN | | EXISTING TOILET FACILITIES |
| | RIVER DIRECTIONAL SIGN | | SWIMMING HOLE |
| | RIVER CULTURAL/ INTERPRETATION SIGN | | HORSE RIDING AREA |
| | PARKING HUB | | |

KEY TO PROJECTS

- | | | | |
|--|----------------------------|--|------------------------------------|
| | TRAILS AND SURFACING | | VEGETATION MANAGEMENT |
| | TRAFFIC MANAGEMENT | | WETLAND DEVELOPMENT |
| | SIGNAGE | | CULTURAL |
| | CONNECTIONS | | PROPOSED PLANTING AND REVEGETATION |
| | MANAGEMENT AND MAINTENANCE | | WATER QUALITY |
| | FURNITURE AND FACILITIES | | |

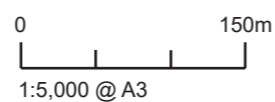

POETS PARK | FUTUTRE OF THE TE AWA KAIRANGI/ HUTT RIVER CORRIDOR | MARCH 2022



PROJECT AREAS

TOTARA PARK FOREST











KEY

- 1 Develop new wetland/ lowland podocarp forest in 'horse paddock' on True Right Bank, by developing a masterplan and development programme, with a view to reinstate groundwater level through minor earthworks, stopping drains, planting and maintenance.
- 2 An opportunity exists within the open space at Riverbank Park to enhance the arrival and connectivity to the Upper Hutt City Centre. This could be complemented by improved access to the Te Awa Kairangi/ Hutt River (UHCC OSS)

LEGEND

- | | |
|---|--|
|  RIVER INFORMATION SIGN |  EXISTING TOILET FACILITIES |
|  RIVER DIRECTIONAL SIGN |  SWIMMING HOLE |
|  RIVER CULTURAL/ INTERPRETATION SIGN |  HORSE RIDING AREA |
|  PARKING HUB | |

KEY TO PROJECTS

- | | |
|--|--|
|  TRAILS AND SURFACING |  VEGETATION MANAGEMENT |
|  TRAFFIC MANAGEMENT |  WETLAND DEVELOPMENT |
|  SIGNAGE |  CULTURAL |
|  CONNECTIONS |  PROPOSED PLANTING AND REVEGETATION |
|  MANAGEMENT AND MAINTENANCE |  WATER QUALITY |
|  FURNITURE AND FACILITIES | |



0 150m
1:5,000 @ A3

TOTARA PARK FOREST | FUTURE OF THE TE AWA KAIRANGI/ HUTT RIVER CORRIDOR | MARCH 2022



TOTARA PARK TO BIRCHVILLE

ISSUES AND ACTIONS

This reach extends 3.9km between Totara Park and Birchville Bridges and is characterised by the distinctive 90-degree bend at Maoribank between Totara Park Bridge and Harcourt Park.

TRAILS AND SURFACING

- Formalise recreational access on the temporary access road between Akatarawa River and Totara Park to provide a loop track between Harcourt Park and Akatarawa Road Bridge

TRAFFIC MANAGEMENT

SIGNAGE AND WAYFINDING

CONNECTIONS

- Enhance links with UHCC mountain bike trails
- The topography of Te Haukaretu Park makes the park difficult to see and access, opening up views from SH2 into the park would be beneficial to this hidden park (UHCC OSS)
- The Little Akatarawa River flows into the Te Awa Kairangi/ Hutt River/Te Awa Kairangi north of Birchville, there is an opportunity to link the esplanade reserve from the Te Awa Kairangi/ Hutt River up the Little Akatarawa River, the QEII reserve and existing esplanade strips into a contiguous reserve. (UHCC OSS)

FURNITURE AND FACILITIES

PLANTING AND REVEGETATION

WETLAND DEVELOPMENT

VEGETATION MANAGEMENT

CULTURAL AND HISTORIC ASSOCIATIONS

MANAGEMENT AND MAINTENANCE RESPONSIBILITY

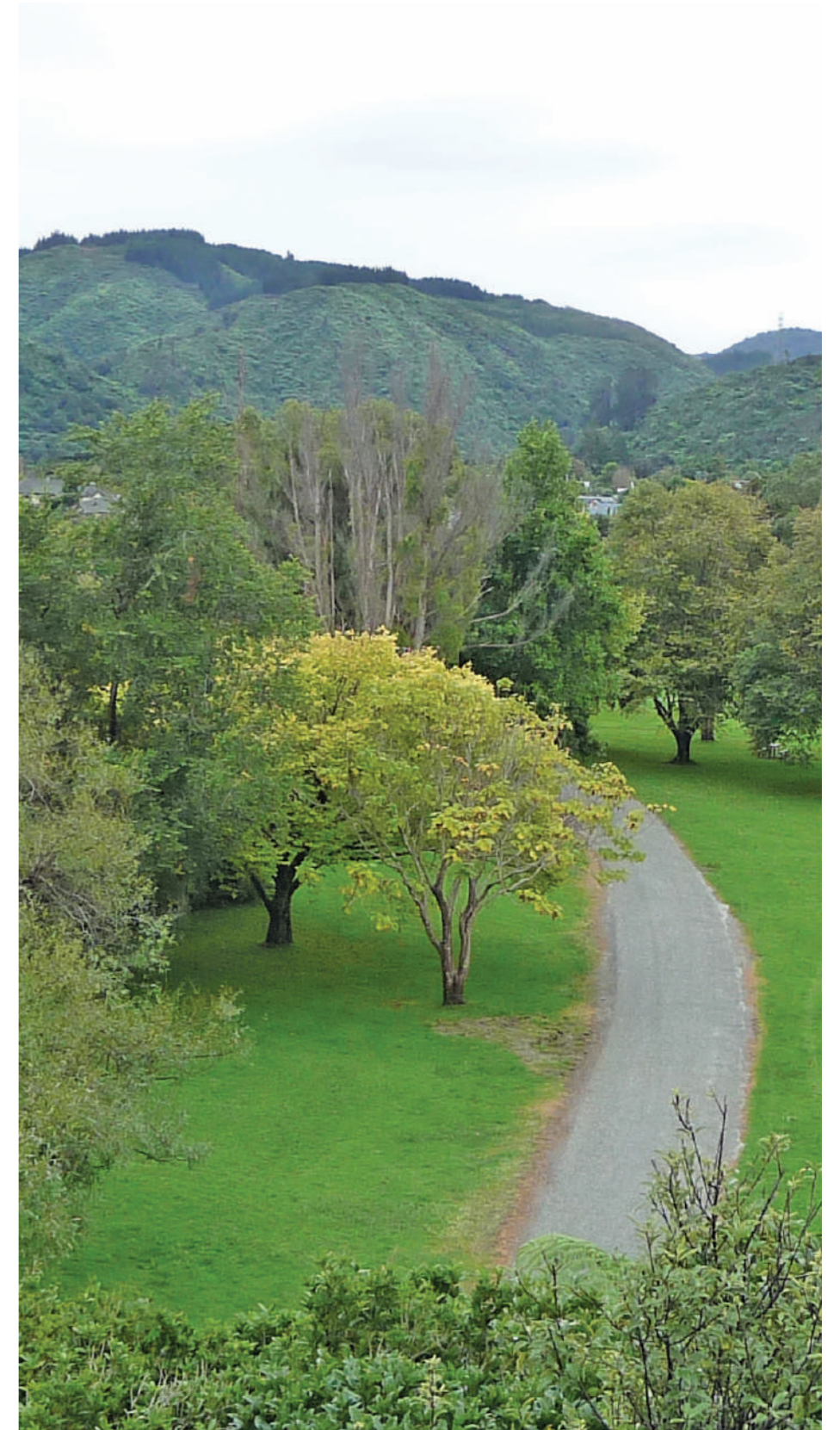







PROJECT AREAS

TOTARA PARK CONNECTIONS









KEY

- 1 Formalise recreational access on the temporary access road between Akatarawa River and Totara Park to provide a loop track between Harcourt Park and Akatarawa Road Bridge
- 2 Open up views from SH2 into Te Haukaretu Park through strategic vegetation removal (UHCC OSS)
- 3 Link the esplanade reserve from the Te Awa Kairangi/ Hutt River up to the Little Akatarawa River, via the the QEII reserve and existing esplanade strips into a contiguous reserve. (UHCC OSS)

LEGEND

- | | |
|---|--|
|  RIVER INFORMATION SIGN |  EXISTING TOILET FACILITIES |
|  RIVER DIRECTIONAL SIGN |  SWIMMING HOLE |
|  RIVER CULTURAL/ INTERPRETATION SIGN |  HORSE RIDING AREA |
|  PARKING HUB | |

KEY TO PROJECTS

- | | |
|--|--|
|  TRAILS AND SURFACING |  VEGETATION MANAGEMENT |
|  TRAFFIC MANAGEMENT |  WETLAND DEVELOPMENT |
|  SIGNAGE |  CULTURAL |
|  CONNECTIONS |  PROPOSED PLANTING AND REVEGETATION |
|  MANAGEMENT AND MAINTENANCE |  WATER QUALITY |
|  FURNITURE AND FACILITIES | |



TOTARA PARK CONNECTIONS | FUTURE OF THE TE AWA KAIRANGI/ HUTT RIVER CORRIDOR | MARCH 2022

BIRCHVILLE TO TE MARUA

ISSUES AND ACTIONS

This reach extends 4.7km between the Birchville Bridge and the Te Marua reservoirs where the river emerges from Kaitoke Gorge.

TRAILS AND SURFACING

TRAFFIC MANAGEMENT

- Enhance river trail link and realign so it continues on the river side of SH2 between Mangaroa River and the Kaitoke Regional Park entrance.
-

SIGNAGE AND WAYFINDING

- Develop suitable signage and elements to highlight start point to Te Awa Kairangi/ Te Awa Kairangi/ Hutt River trail
-

CONNECTIONS

- Enhance links with UHCC mountain bike trails.
 - Future growth in the way of urban expansion is forecast for this area (see the Land Use Strategy for details). As part of the new urban form access and connectivity of open spaces should be considered to enhance the network and make it easy for the community to connect with each other and nature. (UHCC OSS)
-

FURNITURE AND FACILITIES

PLANTING AND REVEGETATION

- Enhance planting on narrow section of trail between river and SH2
-

WETLAND DEVELOPMENT

VEGETATION MANAGEMENT

CULTURAL AND HISTORIC ASSOCIATIONS

- Whakataka Pā, on the site of the Te Marua Golf Course, is a pou and ancestral site of significance to Ngāti Toa which had a shared association with Ngāpuhi war party who engaged in the take over from Ngāti Kahukura-awhitia from the Wairarapa
-

MANAGEMENT AND MAINTENANCE RESPONSIBILITY

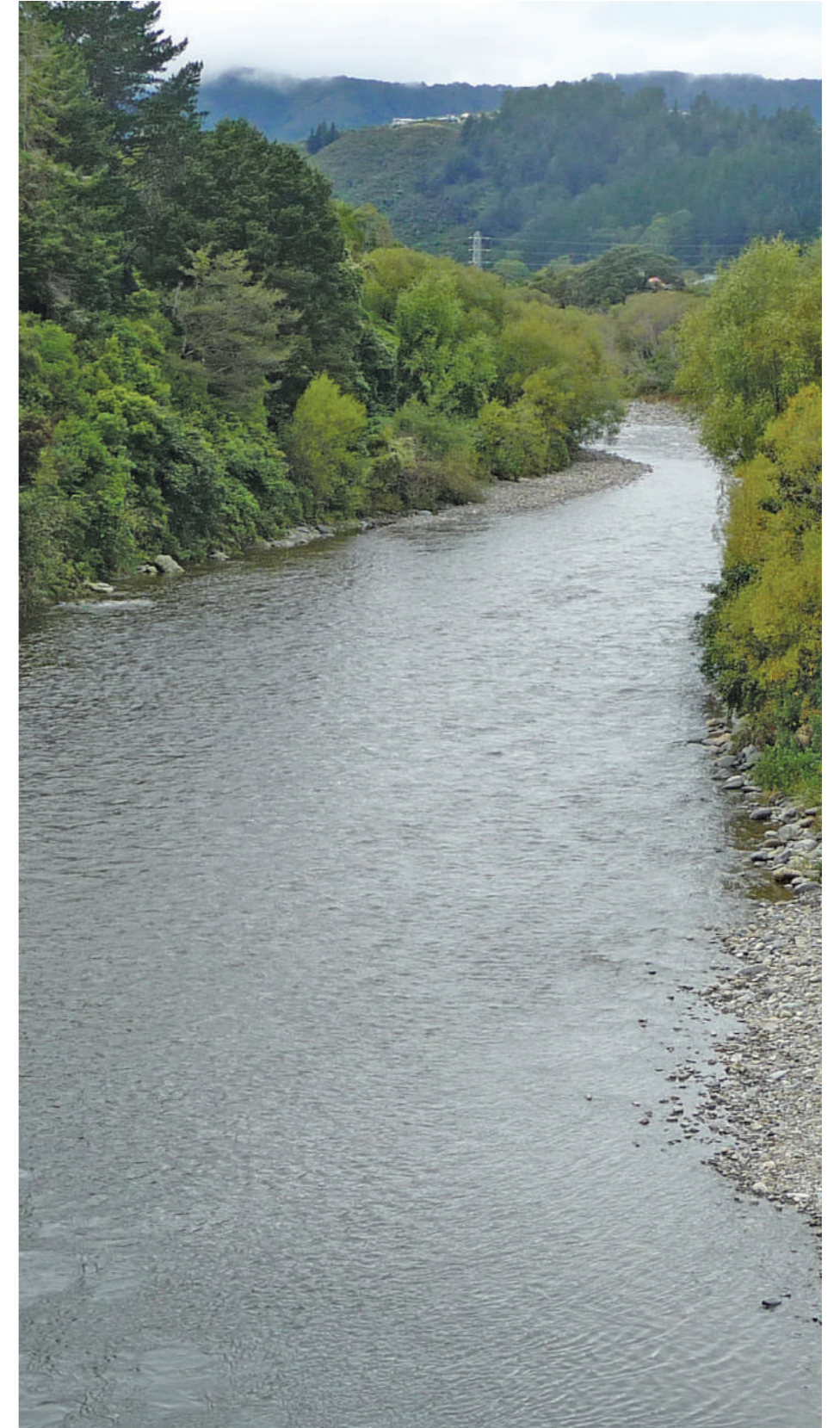







PROJECT AREA

TE MARUA











KEY

- 1 Enhance river trail link and realign so it continues on the river side of SH2 between Mangaroa River and the Kaitoke Regional Park entrance, by bridging across Mangaroa River
- 2 Develop signage and/or interpretation acknowledging the presence of Whakataka Pā and its significance to Ngāti Toa
- 3 Develop suitable signage and elements to highlight start point of Te Awa Kairangi/ Hutt River trail
- 4 Enhance links with UHCC, Remutaka mountain bike trails.
- 5 Enhance planting on narrow section of trail between river and SH2.

LEGEND

- | | |
|---|--|
|  RIVER INFORMATION SIGN |  EXISTING TOILET FACILITIES |
|  RIVER DIRECTIONAL SIGN |  SWIMMING HOLE |
|  RIVER CULTURAL/ INTERPRETATION SIGN |  HORSE RIDING AREA |
|  PARKING HUB | |

KEY TO PROJECTS

- | | |
|--|--|
|  TRAILS AND SURFACING |  VEGETATION MANAGEMENT |
|  TRAFFIC MANAGEMENT |  WETLAND DEVELOPMENT |
|  SIGNAGE |  CULTURAL |
|  CONNECTIONS |  PROPOSED PLANTING AND REVEGETATION |
|  MANAGEMENT AND MAINTENANCE |  WATER QUALITY |
|  FURNITURE AND FACILITIES | |



0 250m
1:7,500 @ A3

TE MARUA | FUTURE OF THE TE AWA KAIRANGI/ HUTT RIVER CORRIDOR | MARCH 2022



DESIGN GUIDELINES



DESIGN GUIDE

TRAILS AND SURFACING

Traditionally, trail surfacing along the river corridor has been gravel soft surfacing. However, as more people use the river corridor for commuting, parts of the trail have been finished in tarmac.

Realignment of the trail in some locations between nodes will create a more diverse and interesting route for cyclists and walkers and also create enclosure and reduce exposure.

TRAIL SOFT SURFACING

In general, gravel surfacing will be used throughout the trail. The trail should be designed to be able to accommodate cycling and walking access and occasional GWRC heavy vehicles associated with river and berm works and maintenance.



Existing trail soft surfacing



Soft surfacing for vehicle access

TRAIL HARD SURFACING

In areas of high commuter use, hard surfacing will be used.



Existing trail hard surfacing

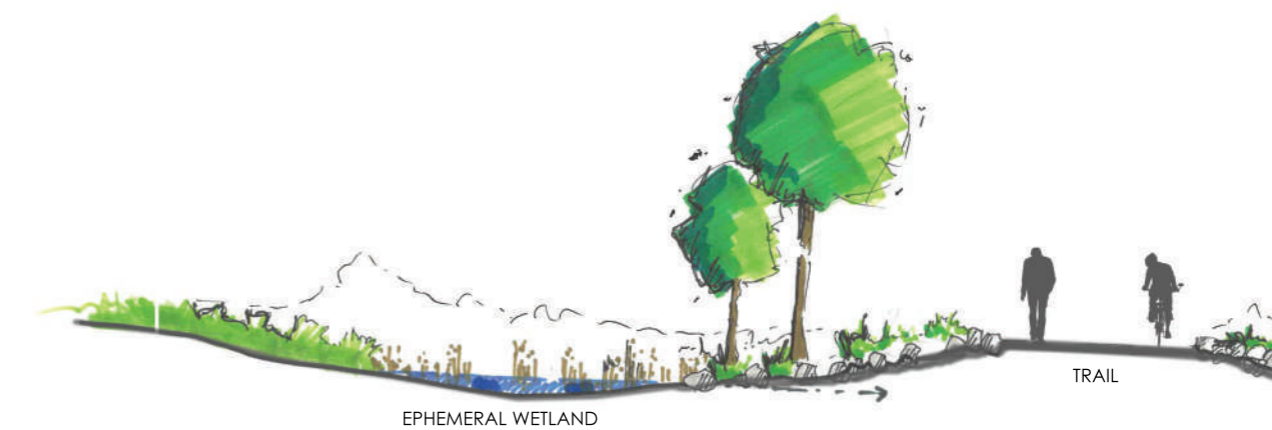

Typical proposed trail section adjacent to ephemeral wetland area

DESIGN GUIDE

TRAILS AND SURFACING - TYPICAL DETAILS

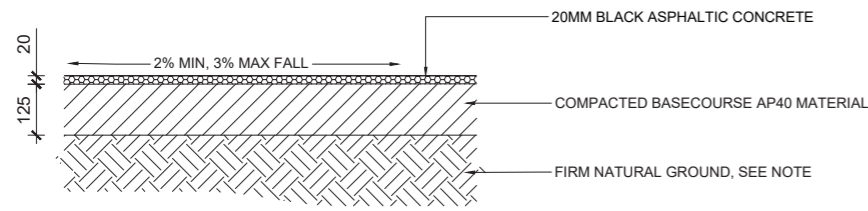

TYPICAL ASPHALT TRAIL SURFACE DETAIL LIGHT DUTY 1:20

Based on NZ Cycle Trail Design Guide

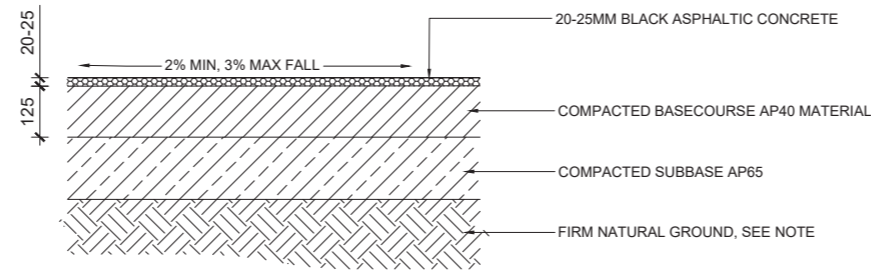

TYPICAL ASPHALT TRAIL SURFACE DETAIL HEAVY DUTY 1:20

Based on NZ Cycle Trail Design Guide

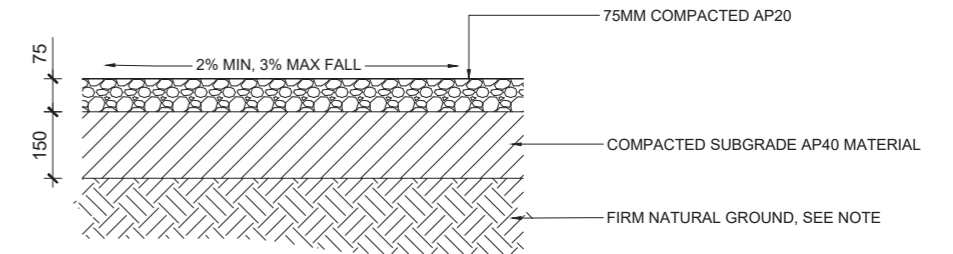

TYPICAL GRAVEL TRAIL SURFACE DETAIL 1:20

For firm clay silt or ash soils. Refer to DOC Track Construction and Maintenance Guidelines (July 2008) for pavement and surface options for other scenarios

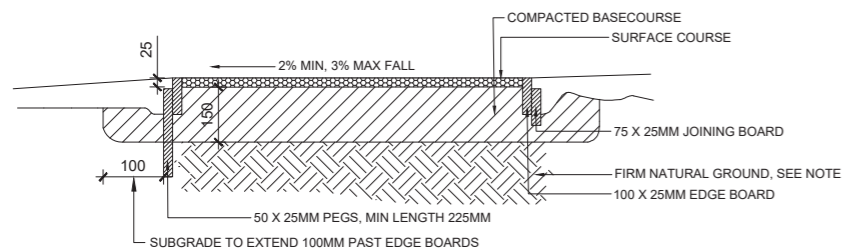

TYPICAL TIMBER EDGING DETAIL 1:20

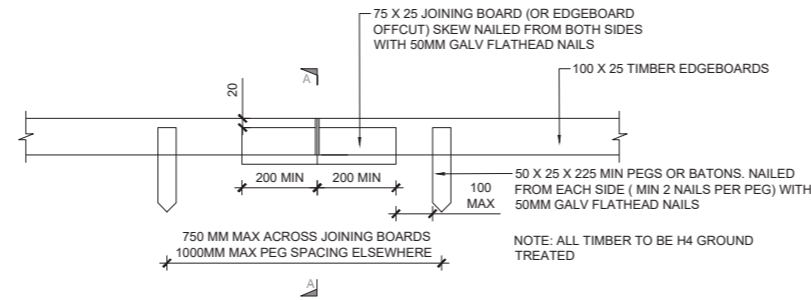

TYPICAL TIMBER EDGING DETAIL SECTION 1:20

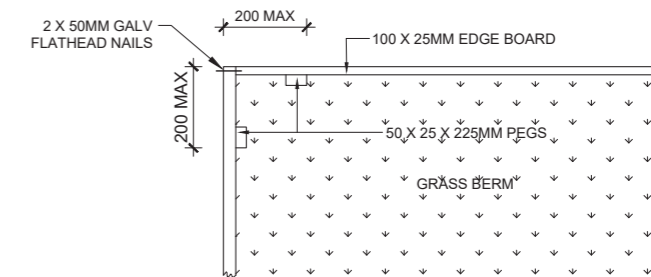

TYPICAL TIMBER EDGING DETAIL PLAN 1:20

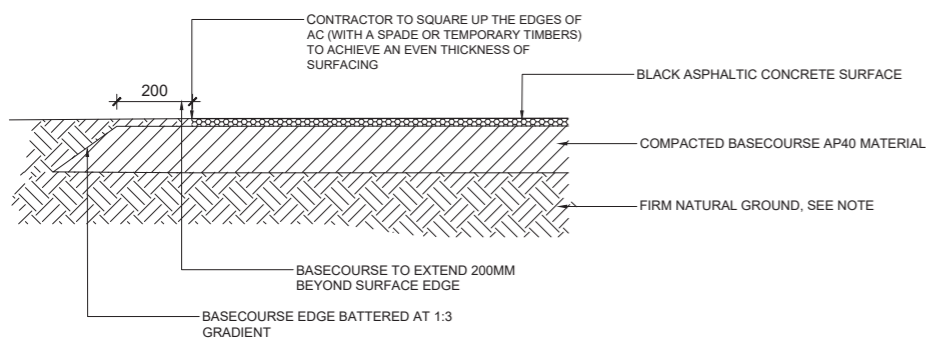

TYPICAL SECTION DETAIL ASPHALT PATH WITHOUT TIMBER EDGE 1:20

Based on NZ Cycle Trail Design Guide

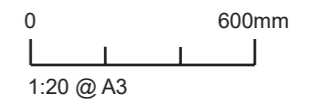

NOTE: WHERE GROUND MATERIAL IS EITHER WET OR SOFT (E.G. SWAMP OR PEAT), THEN A FILTER FABRIC SHOULD BE ADDED TO STOP THE CONSTRUCTION METAL COURSE FROM MIXING WITH THE GROUND AND THUS ACHIEVE A LONG-LASTING PATH. ENGINEERING ADVICE SHOULD BE SOUGHT IN SUCH A SITUATION TO AVOID HIGH CONSTRUCTION AND MAINTENANCE COSTS.

REFER TO SNZ HB 8630:2004 AND NZ CYCLE DESIGN GUIDE FOR INFORMATION ON CHOOSING TRAIL TYPE APPROPRIATE TO LOCATION

DESIGN GUIDE

VEHICLE CONTROL

Vehicle access to the river bed is an ongoing issue throughout the river corridor. Restricting vehicle access to defined places/nodes will reduce the areas of conflict. Continuous vehicle access along the river berm will be for GWRC vehicles only; controlled by a vehicle barrier gate where required.

Access points and routes will ideally avoid or at least minimise vehicle / cyclist / pedestrian conflicts. Safety improvements to vehicle entry and egress are required in some locations.

While looking to achieve a visually enhanced environment and keeping motorised vehicles out, barriers still need to enable the passage of people and animals. Walkers, cyclists, runners, walkers and runners with prams, wheelchair users and people riding horses all need to be able to pass barriers that will keep vehicles and motorbikes out.

INFORMAL VEHICLE BARRIERS

Informal vehicle barriers such as concrete blocks and rocks can be used to separate vehicles from pedestrians and restrict vehicle access. They can also be used as informal seating.

Parking areas can also be informally defined by use of typical river elements (eg. large rocks, re-purposed concrete blocks, heavy wharf timbers).

The concrete blocks can be used in innovative ways and do not need to be simply arranged in a continuous row. The blocks could be partly buried or arranged to provide a relatively informal edge where planting can be incorporated as shown in the accompanying diagrams.

Similarly, large rocks which are used to reinforce the edge of the river channel can be used in different ways to achieve a physical barrier but avoiding placing the rocks in a line on the ground surface.



Concrete blocks



Rock edges can be used to control vehicle access

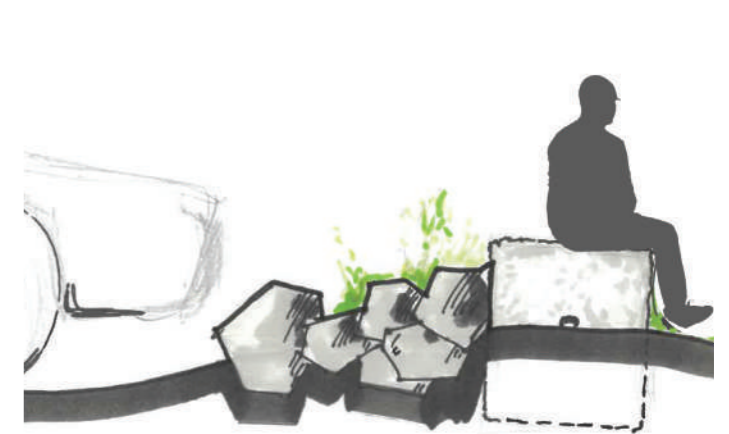

Rock edges can be used as vehicle barrier and informal seating

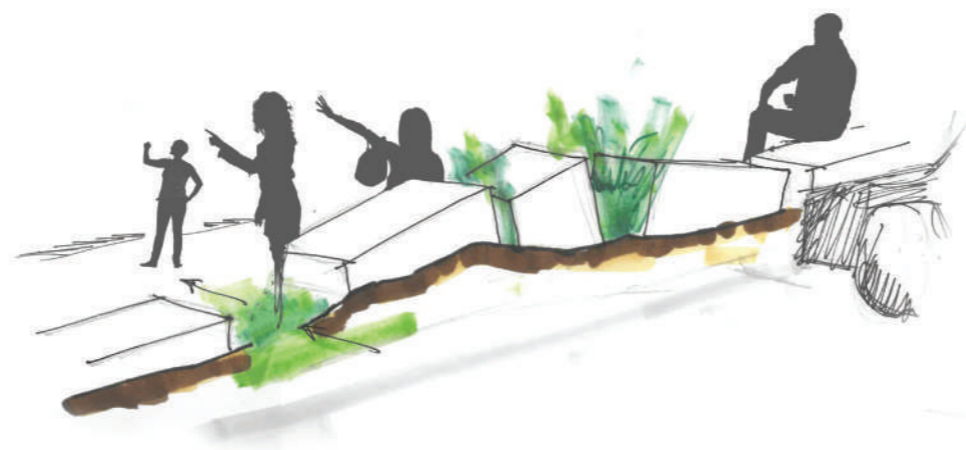

Concrete blocks used to separate vehicles from pedestrians

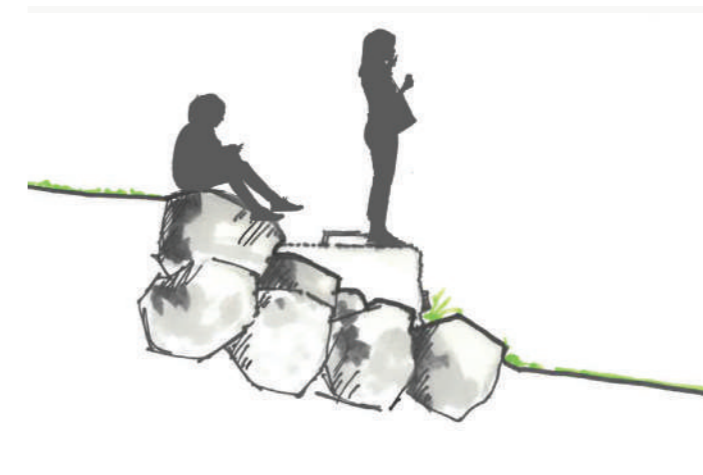

Concrete block/rocks as groynes/seating

DESIGN GUIDE

VEHICLE CONTROL

PARKING HUBS

The Future of the Te Awa Kairangi/ Hutt River corridor seeks to establish parking “hubs” which would accommodate vehicle access and carparking within restricted areas of the river corridor. Restricting vehicle access to defined places/nodes will reduce the areas of conflict. Continuous vehicle access along the river berm will be for GWRC vehicles only.

Access points and routes will ideally avoid or minimise vehicle / cyclist / pedestrian conflicts. Safety improvements to vehicle entry and egress are also required in some locations.

Parking hubs are ideally located set back from the river edge or in a position which prevents them from dominating the environment, which could be rewarded with car shade created by tree planting.

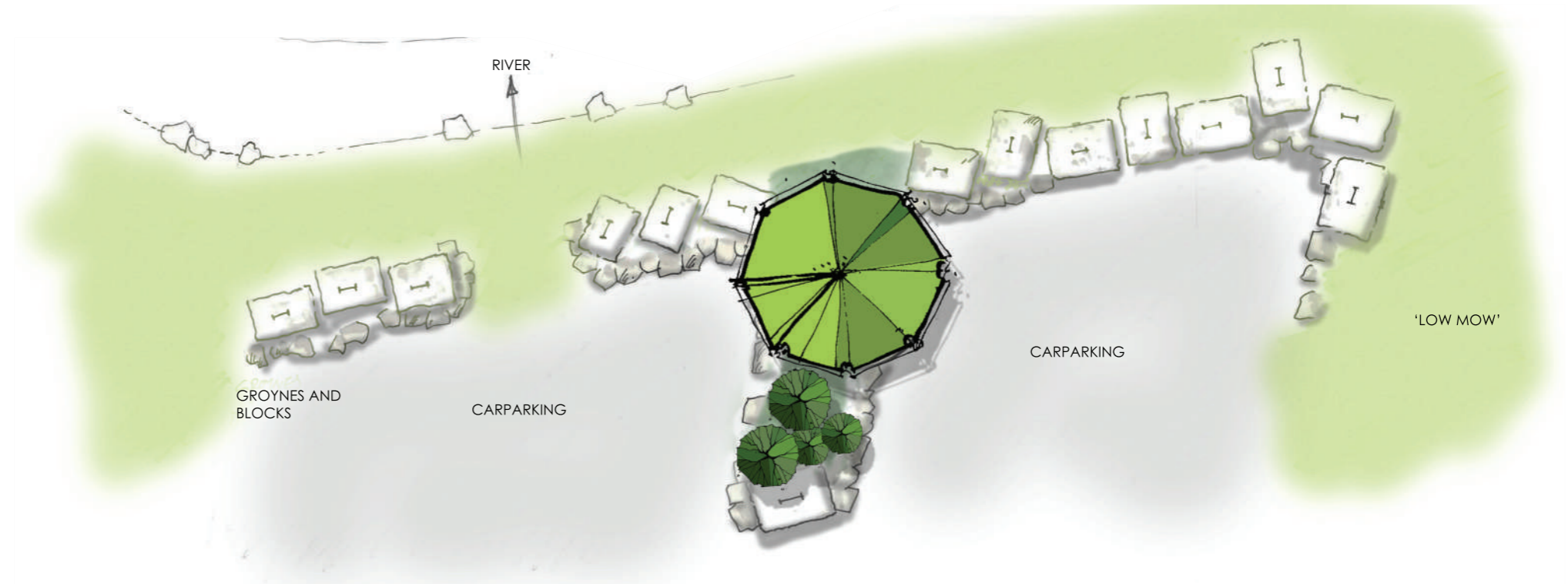

Example parking hub layout, featuring concrete blocks and groynes arranged in a random edging pattern, with trees for shade and shelter. Clear access points to the river are also provided.

FORMAL VEHICLE BARRIERS

Formal vehicle barriers may be required in high use areas and areas where cycle and maintenance access is also required.



Existing bicycle squeeze gate on the River Trail



Existing bicycle gate on the river trail near Silverstream



Existing simple bollards with chain and rock edging

RIVER-WIDE ACTIONS

PROPOSED PARKING HUBS

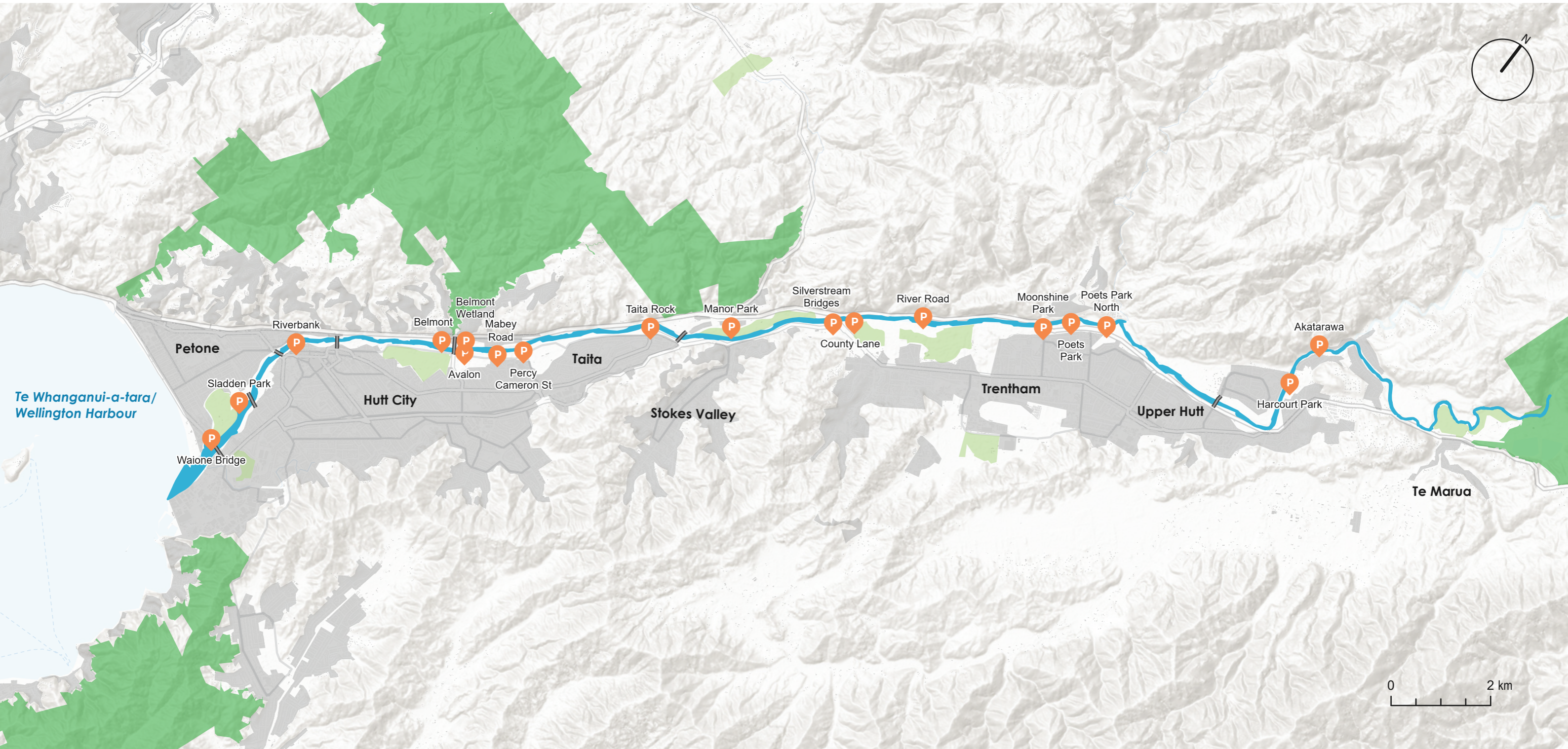

LEGEND

- PARKING HUBS
- BRIDGES
- HUTT RIVER
- REGIONAL PARKS
- GOLF COURSES
- URBAN AREA

Sourced from LINZ, Stats NZ, Esri, GWRC, HCC, UHCC, BML

DESIGN GUIDE

VEHICLE BARRIERS - TYPICAL DETAILS

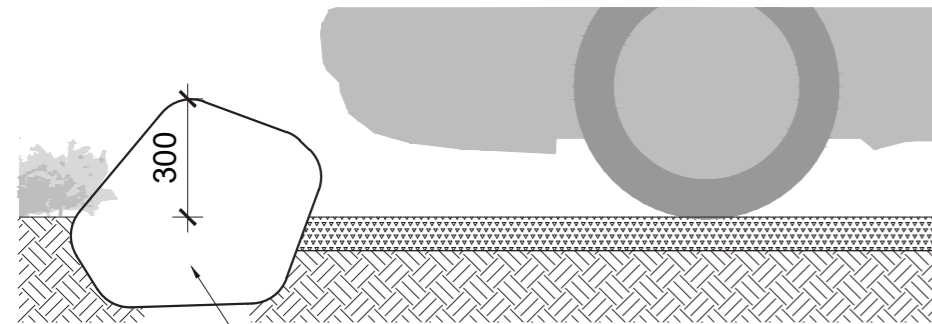

ROCK EDGING TO CARPARKING AREA FROM RIVER ROCKS. MINIMUM 2/3 ROCK BURIED INTO GROUND AND BACKFILLED TO MATCH SURROUNDING GROUND LEVEL. ROCK PROTRUSION TO BE MIN APPROX 300MM.

ROCK EDGING TO CARPARK AREAS 1:20



TYPICAL ROCK BARRIERS

Randomly placed rock barriers to prevent vehicle access



TYPICAL TIMBER BOLLARD WITH WIRE ROPE

Timber bollard with wire rope chain to define trail edge and prevent vehicle access

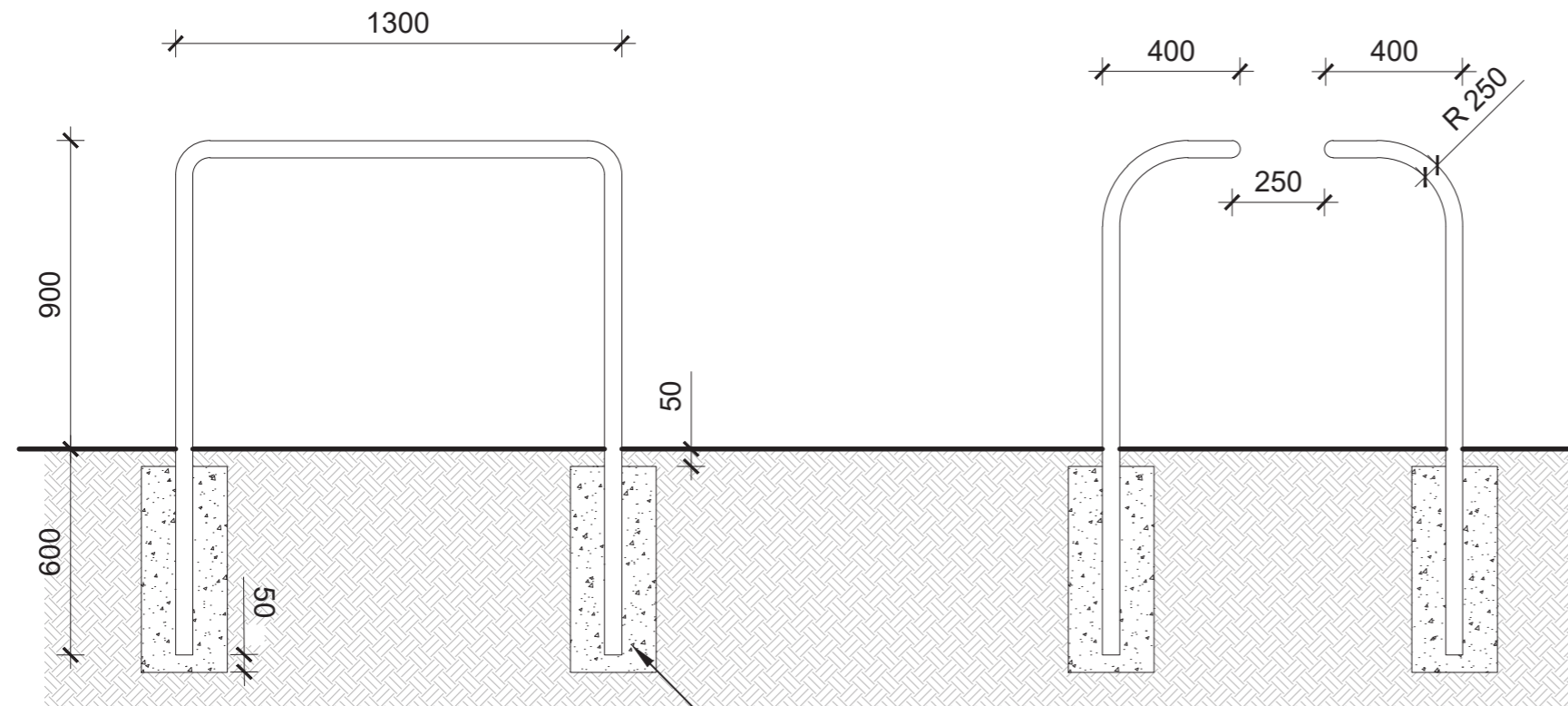

CONCRETE FOOTING 20MPA

TYPICAL CYCLE SQUEEZE BARRIER: SIDE VIEW 1:20

TYPICAL CYCLE SQUEEZE BARRIER: FRONT VIEW 1:20

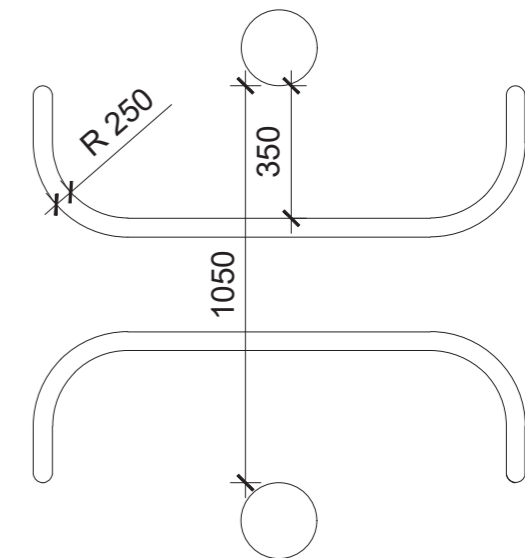

TYPICAL CYCLE SQUEEZE BARRIER: PLAN VIEW 1:20

DESIGN GUIDE

FURNITURE AND FACILITIES

SITING AND DESIGN

Siting of structures in the river corridor has the potential to create issues in the event of a flood. Siting, design, materials and the level of robustness are key factors to consider. Structures and materials need to be simple and robust and the cue to their design should be based and where possible use the materials employed in river management (e.g. rock, simple concrete block forms, heavy bridge, wharf timbers etc)

The type and of furniture and facilities provided should be determined by the location and use of the trail. If a new structure is required, there is opportunity to incorporate more than basic toilets in the structure (e.g. shelter, drinking water fountain, including for dogs).

TOILETS, FACILITIES AND FURNITURE

A simple, robust pre-fabricated structure could be utilised in many locations along the river. Seats, signs, barrier and bollards are to be simple and robust and able to withstand potential flooding events and reflect surrounding environmental conditions; avoid 'fussy' and urban elements and details.



Example shelter which could contain toilets and other facilities



Simple and robust picnic table on the trail near Stokes Valley



Example informal seating using timber posts (to be anchored/buried in the river environment)

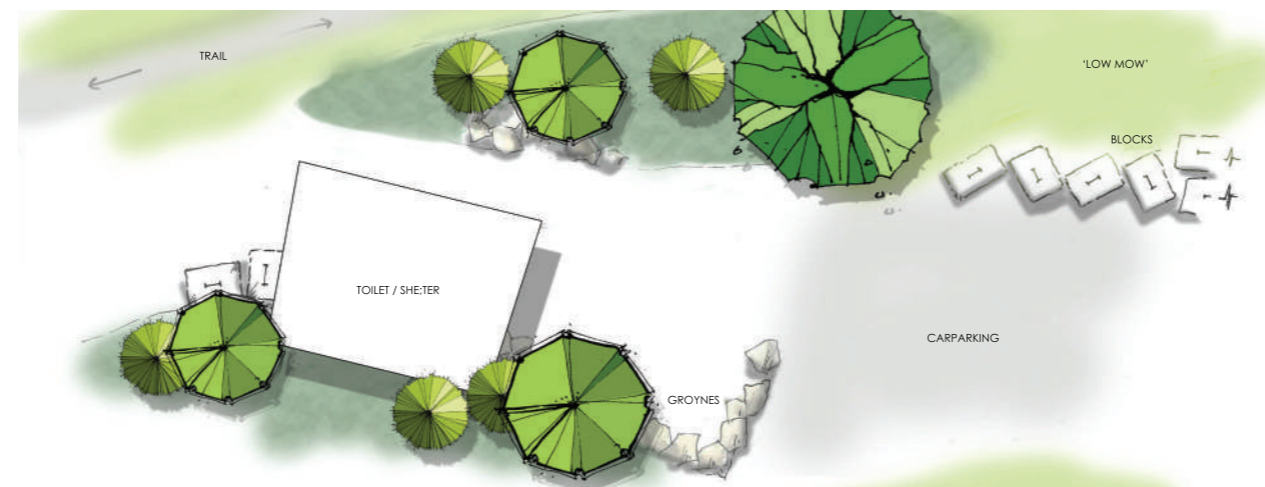

Example shelter and carparking layout

DESIGN GUIDE

TRAIL FURNITURE - TYPICAL DETAILS

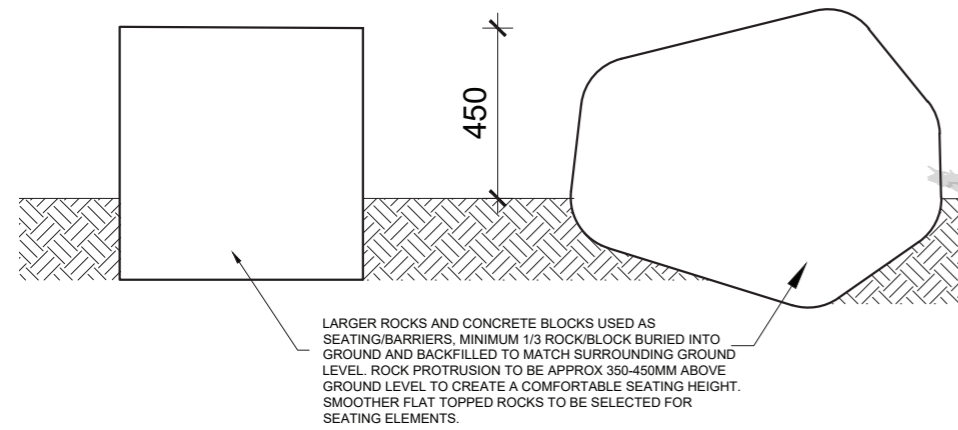

ROCK/CONCRETE BLOCK SEATING 1:20

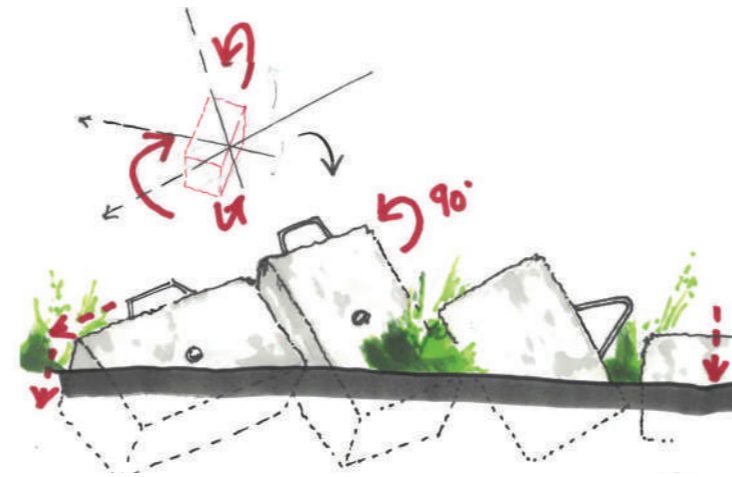

CONCRETE BLOCKS ROTATED

Concrete blocks rotated before burying into ground to create random forms and shapes

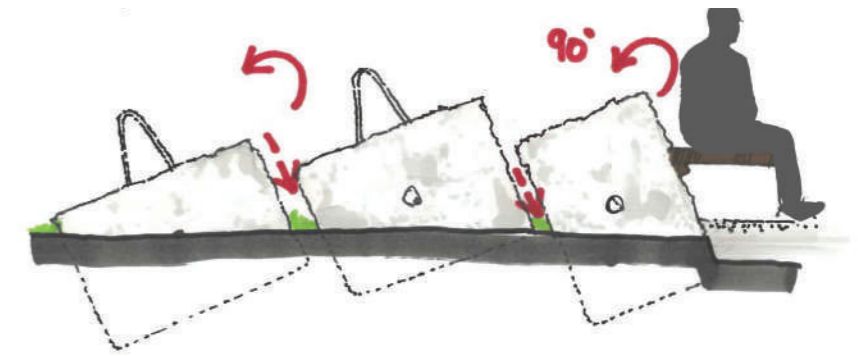

CONCRETE BLOCKS ANGLED

Concrete blocks set into the ground at a 45 degree angle could provide a mounting surface for timber bench seating



TYPICAL SQUARE REMOVABLE TIMBER BOLLARD

Bollard with reflective strip and simple lock for removal



TYPICAL PICNIC TABLE

Simple and robust form with simple ground footing the minimise the trapping of debris during flood events

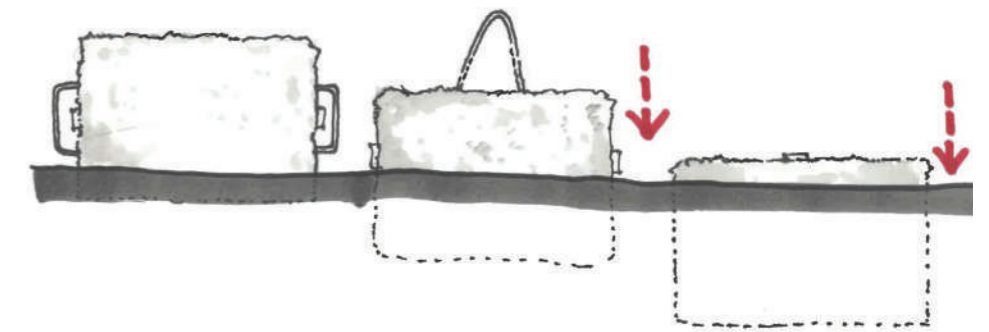

CONCRETE BLOCKS RECESSED INTO GROUND

Concrete blocks recessed into ground to provide different barriers, seating or delineation of areas

DESIGN GUIDE

SIGNAGE AND WAYFINDING

SIGNAGE

Current trail signage is a mix of styles. The development of a consistent signage family will establish an identity for the trail and assist with wayfinding.

Throughout the trail there are opportunities for both directional/informative signs and interpretative signage to relate to stories associated with history of the site and surrounding area (e.g. iwi connections etc.)



An example of existing timber location signage present along the trail.



Existing directional signage is nearing the end of its life and may be difficult to read or navigate from



Existing signage on the trail obscured by vegetation



Top: Existing warning signage relating to toxic algae has become damaged due to wind and weather

Below: a mixture of signage styles is present throughout the trail, with no consistent theme.

DESIGN GUIDE

SIGNAGE AND WAYFINDING

A palette of simple and robust signage should be developed to assist with both wayfinding and interpretation. Signs to mark the beginning and end of the trail would also form a part of this package. Temporary signage to warn of dangers such as flooding and toxic algae also needs to be developed. The following illustrations show an example Sign Family with trail head marker, directional signs and information/interpretation signs, using simple robust materials similar to the existing trail signage.



DESIGN GUIDE

SIGNAGE AND WAYFINDING

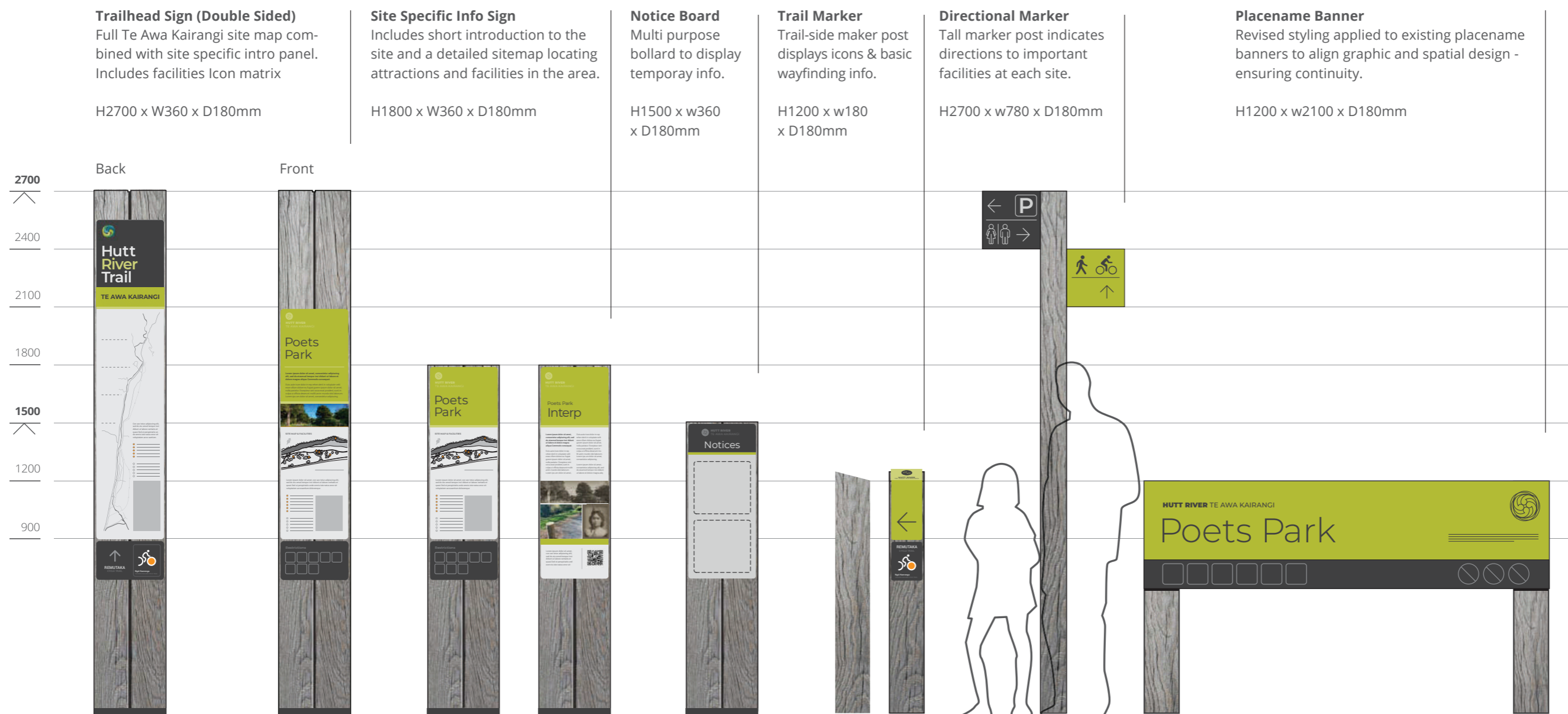

DESIGN GUIDE

SIGNAGE AND WAYFINDING



deanedgingtondesign | 2021

DESIGN GUIDE

SIGNAGE AND WAYFINDING

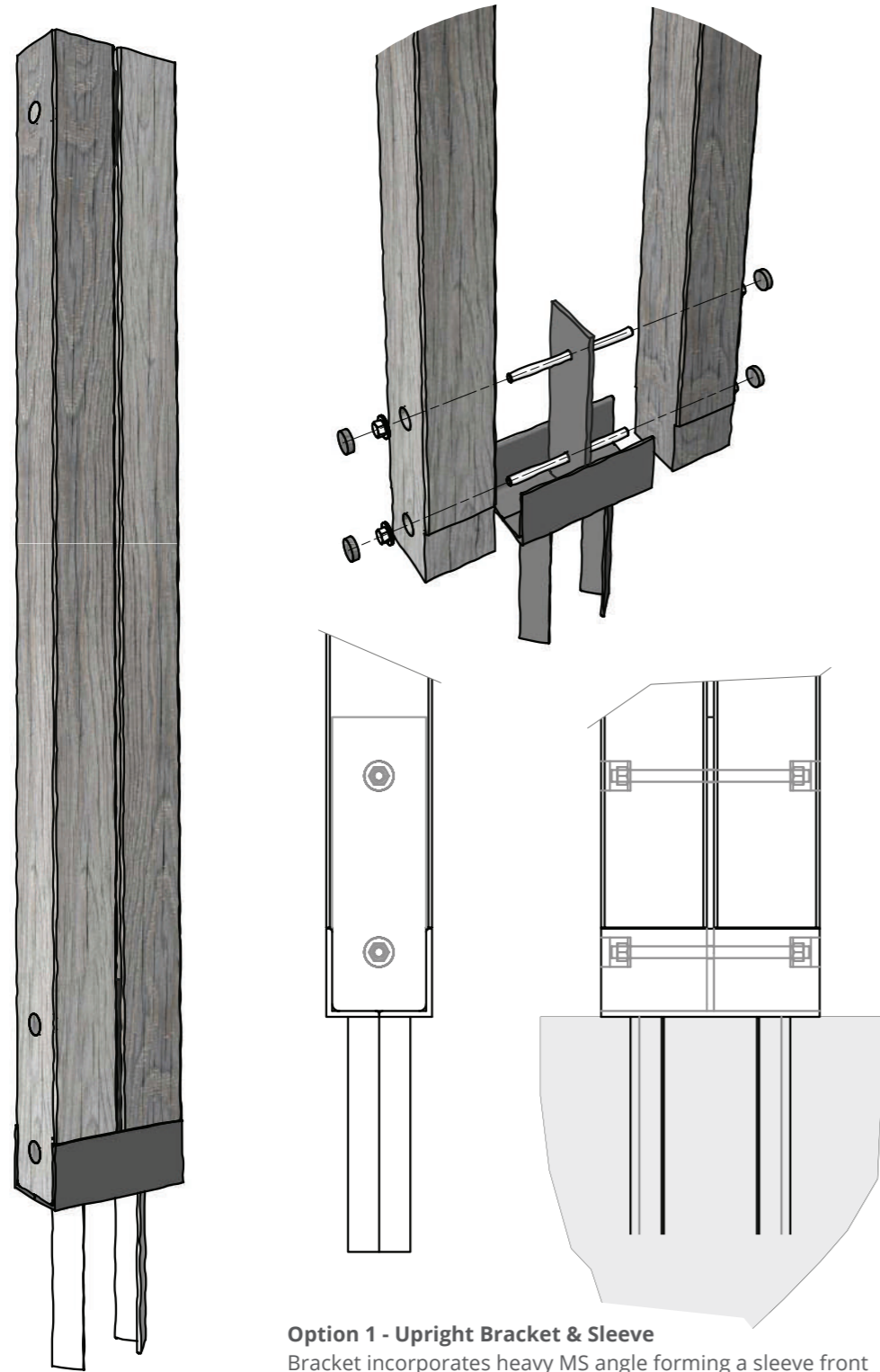

Option 1 - Upright Bracket & Sleeve

Bracket incorporates heavy MS angle forming a sleeve front & back. Fixed droppers are embedded in concrete footing securing bracket to ground. Posts are clamped to upright bracket with heavy fixings at multiple places.

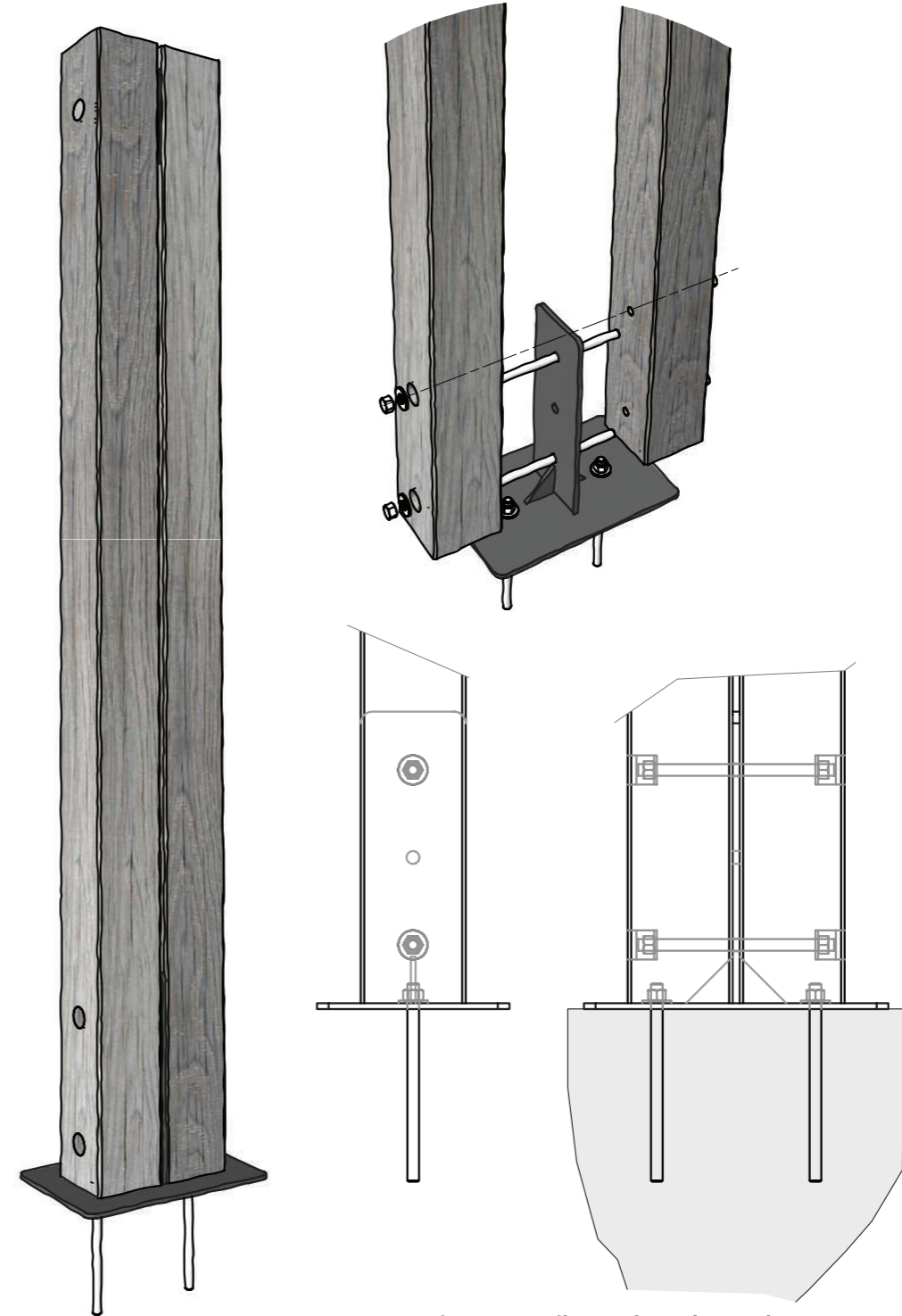

Option 2 - Cantilevered Bracket & Plate

Heavy MS plate with upright MS bracket reinforced with gussets. Bracket assembly is bolted to concrete footing with anchors. Posts are clamped to upright bracket with fasteners at multiple places.

DESIGN GUIDE

SIGNAGE AND WAYFINDING

Construction Material

A sustainable timber choice for this application may include Eucalypt or Macrocarpa. Eucalypt having better durability characteristics. To ensure a natural aesthetic and eliminate the requirement for toxic coatings, the timber will be left to silver naturally.

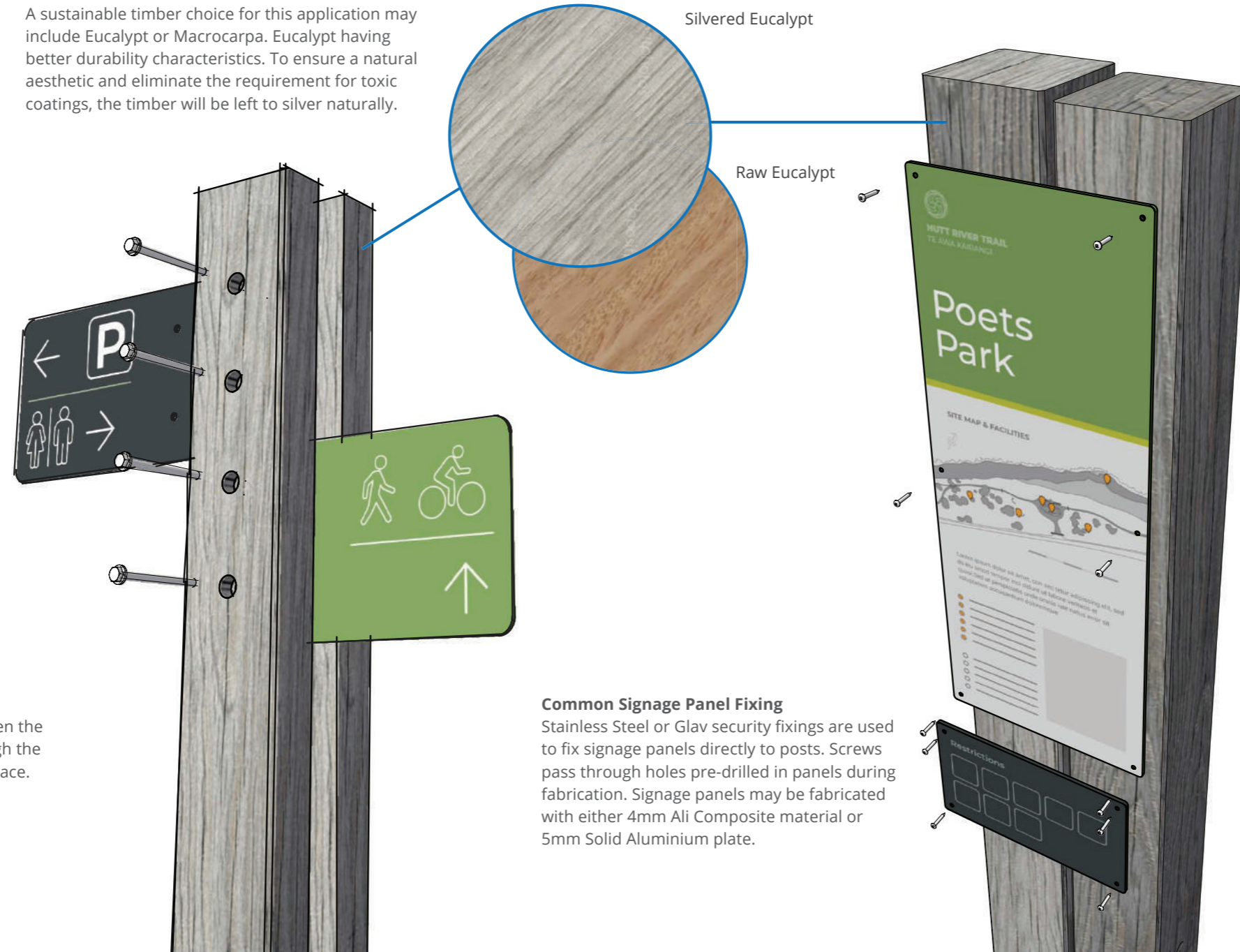

Cantilevered Panels

Wayfinder panels are mounted between the dual upright posts. Fixings pass through the posts and signage clamping them in place. Spacers are used to allow panels to be swapped out of post assembly.

Common Signage Panel Fixing

Stainless Steel or Glav security fixings are used to fix signage panels directly to posts. Screws pass through holes pre-drilled in panels during fabrication. Signage panels may be fabricated with either 4mm Ali Composite material or 5mm Solid Aluminium plate.

RIVER-WIDE ACTIONS

PROPOSED INFORMATION SIGNS



LEGEND

- INFORMATION SIGNS
- REGIONAL PARKS
- BRIDGES
- GOLF COURSES
- HUTT RIVER
- URBAN AREA

Sourced from LINZ, Stats NZ, Esri, GWRC, HCC, UHCC, BML

DESIGN GUIDE

PLANTING AND REVEGETATION

European settlement began in the Hutt Valley around 1840, and although the dangers of flooding delayed widespread settlement, within 40 years the forests which covered the entire floodplain had been cleared to make way for development. For thousands of years these forests had controlled the river alignment, the processes of erosion and sediment transport, and the force of the river in flood. Deforestation upset the natural balances within the river system, resulting in rapid changes in river alignment and flooding became a threat to life and property in the area.

Ongoing river management works have been required to maintain the river alignment, manage the accumulation of river gravel and contain the erosive forces of the river in flood. From 1865 until the 1960s little consideration was given to the impacts of mechanical methods or the use of river engineering structures that were used to manage the river. These methods led to a severe deterioration of the river environment.

Since 1972, river management techniques have been changed to re-establish vegetative bank-edge protection and healthy riparian ecology. This has been achieved by careful management of gravel extraction and by planting fast-growing exotic trees (mainly willows). All new river works are designed to minimise environmental effects, increase the use of native vegetation within the river corridor, and to enhance the river landscape.

Vegetation along the river corridor provides important ecosystem services such as cleansing the air, producing oxygen, storing carbon and moderating air temperature. Plants used for flood protection provide erosion control and runoff filtering. Willows have historically dominated flood protection planting and will continue to be used. However, using more native plants increases indigenous biodiversity. This increase broadens the range of ecosystem services and improves environmental resilience.

Native plants are also culturally significant and an important part of New Zealand's national identity. Tangata whenua value many native plants for a range of traditional uses. Harakeke in particular was present in abundance along the river and was an important resource.

Planting within the river corridor should include a range of native and exotic vegetation types for different purposes (e.g. as a barrier, for shade, shelter, enclosure, canopy, habitat/ecological function and cultural recognition).

Fast-growing, easily established exotic tree species can be used to create shelter and shade in open parts of the river corridor.

Mass planting of native tree and shrub species in places along river edge is encouraged to create habitat, reinforce existing native vegetation and to create barriers where required.

A key issue for the health of the river is the management of stormwater from surrounding roads before being discharged into the river. There is potential in a number of locations to harness road runoff to create a wetland type environment. A pilot project has been constructed at Belmont.

Identified access points to the river edge will require removal of pest plants and unwanted vegetation and ongoing management of these areas.

In some areas, minor earthworks and re-contouring of open grassed areas can be undertaken to create variety of landform, form new habitat and reduce mowing.



New planting near Pomare Bridge featuring biodegradable plant protectors



Fast growing exotic species such as willow have been planted along the river edge



Establishing areas of native planting near Silverstream Bridges



Establishing wetland planting at Belmont



Exotic species planted for shade, shelter and amenity

DESIGN GUIDE

PLANTING AND REVEGETATION

In general, native plants are best suited to:

- Small waterways (< 2m wide) if bank heights are less than 2m
- Buffer zone front edge in larger rivers where there is low flow velocity and no active erosion
- Behind hard or soft (willow) front edge buffer zone protection
- In combination with willow or exotic 'nurse' planting (see 4.2.4 below)
- Readily accessible sites where the more demanding planting and maintenance will be easier
- Berms, especially on large berms back from the river channel, with better soil conditions
- Shaded and sheltered sites – for both planting and for natural regeneration
- Sites where grazing stock is absent or can be fenced out
- Rivers, or parts of the river, that are being managed to achieve a more natural flow pattern (e.g. meandering).

Willows are best suited to:

- Buffer zones where front edge protection is needed but there is no hard structure protection
- River or stream banks > 2 m height
- Soil lacking or weakly structured e.g. disrupted by major ground works
- Exposed site with little shade or shelter
- Fast establishment is required
- Narrow river berm
- Fencing to exclude stock is not feasible
- Budget is limited.

Alders and poplars are examples of other fast-growing hardy species also used for soil protection. They are less suited to buffer zone protection but can be used for tall group planting in river berms. They can provide an attractive visual feature in the river corridor while offering shade and shelter to 'nurse' slower growing native species that can eventually replace them.



DESIGN GUIDE

OPPORTUNITIES FOR NATIVE PLANTING

Native plants can be introduced in different ways along rivers and small waterways, depending on site factors, as shown in these typical situations

KEY

- ① Native planting inside bend, easy access
- ② Native regeneration within willows, seed from KNE
- ③ Intermixed planting, with groynes reinforcing straight river edge
- ④ Remnant oxbow, good soil and opportunity for wetland plants.
- ⑤ Willow only for critical riverbank protection below narrow berm, berm kept mown for stopbank visibility
- ⑥ Native planting brought close to river edge in good topsoil above hard structural protection
- ⑦ Tall poplars shelter and shade native planting
- ⑧ Willow only on steep banks > 2m height
- ⑨ Native planting behind front edge willow protection
- ⑩ Native planting on stream banks < 2m high
- ⑪ Willow planting on stream banks > 2m high
- ⑫ Stopbank kept in grass and not planted to keep intact and easily observed.

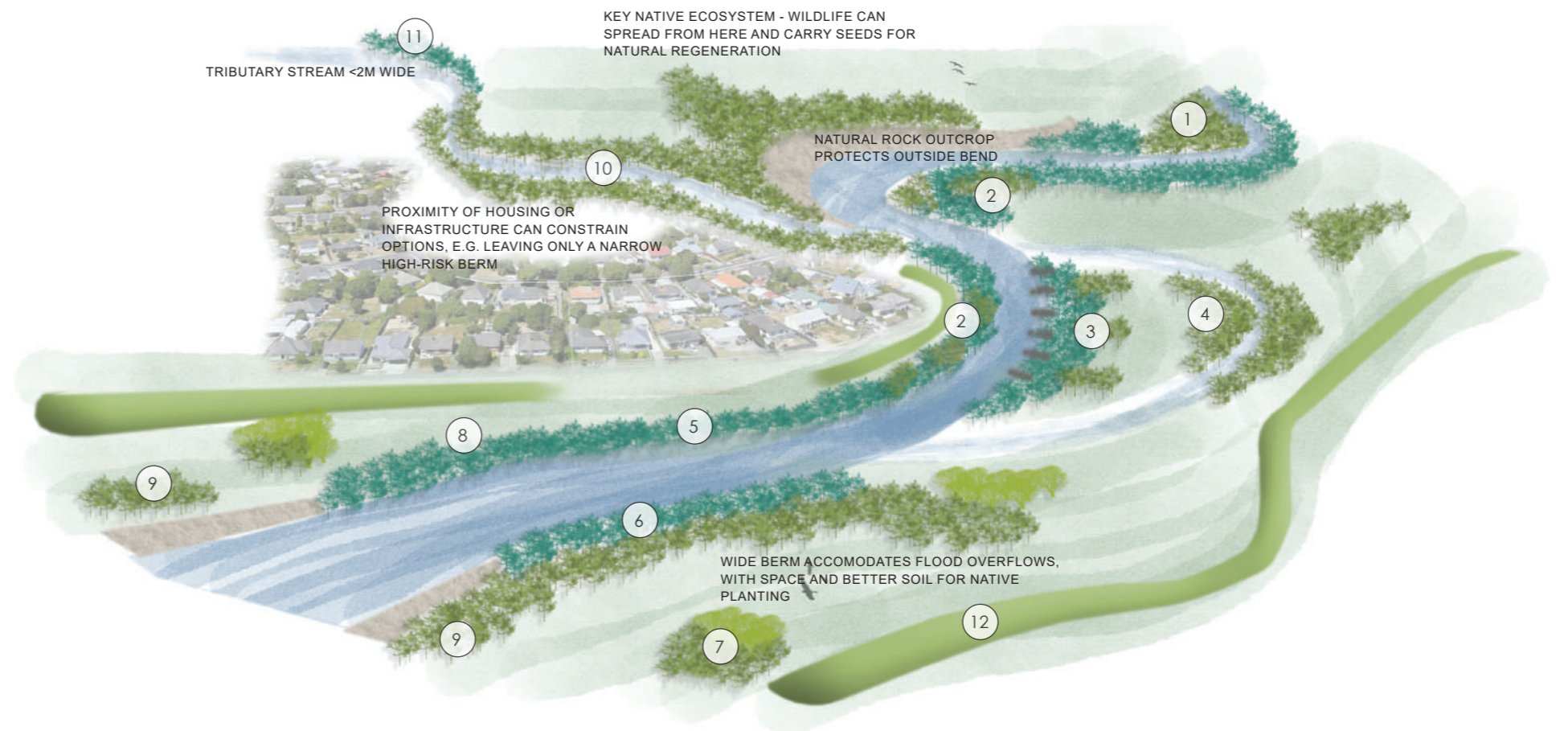

OUTER CURVES OF RIVER BENDS ARE MORE PRONE TO EROSION
INNER CURVES ARE LESS PRONE TO EROSION

INCREASING, SIZE, SPEED AND FORCE OF FLOOD FLOWS
WIND FUNNELLING DOWN THE VALLEY IS HARD ON NATIVE PLANTS

DESIGN GUIDE

BUFFER ZONE PLANTING

Planting native species can be safely used where there is a low erosion risk (i.e. the channel is less than 2 metres wide with banks less than 2 metres high and gently sloping). The cost of planting is justified by the likely success of planting onto a favourable site (good soil) and the potential to enhance water quality (shade and shelter), as well as increasing riparian biodiversity. Use hardy pioneer plants to optimise survival. They will usually close over the ground after 4-5 years, reducing maintenance.

SMALL STREAM RIPARIAN PLANTING

Year 1: On small streams, low-growing sedges, toetoe and flax can be included in the first planting of hardy, fast-growing native species

Year 10: The first planting is well-established, with an organic soil layer developing. The environment is suitable for enhancement planting of taller but slow growing native trees (e.g. podocarps).

Refer Planting - Typical Details for further detail.



Year 1 (stream <2M)



Year 10 (stream <2M)

WILLOW POLE BUFFER ZONE PLANTING

Plant willows in situations of high erosion risk and/or where the soil is of poor structure and fertility. Over time, they will create conditions more suited to native plants, which may regenerate naturally amongst the willows (see right) or can be helped along.

Refer Planting - Typical Details for further detail.

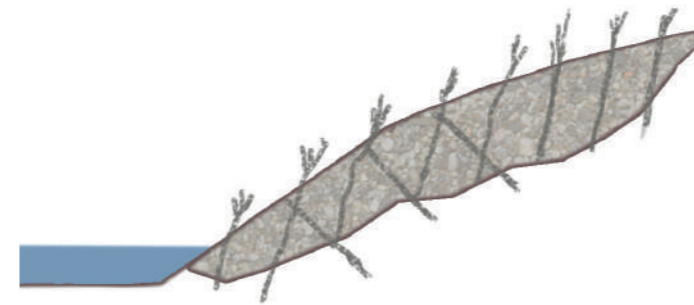

The buffer zone has been reshaped, comprising mainly river stones and gravel with some sediment in the gaps. Willow poles alone are used to quickly stabilise the river edge and hold sediments.

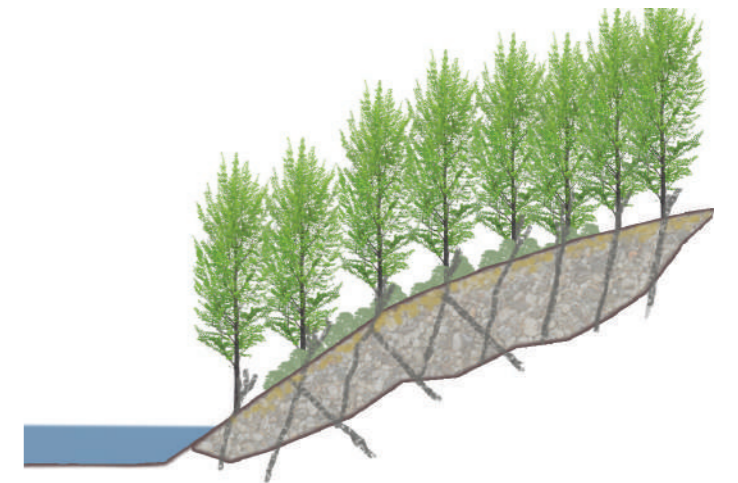

Willows are now well-established trees. Grass cover under the trees has helped to catch sediments so an organic top layer has formed. Native seedlings are developing well with the improved soil, shade and shelter. The willows continue to provide edge protection.

DESIGN GUIDE

BUFFER ZONE PLANTING - TYPICAL DETAILS

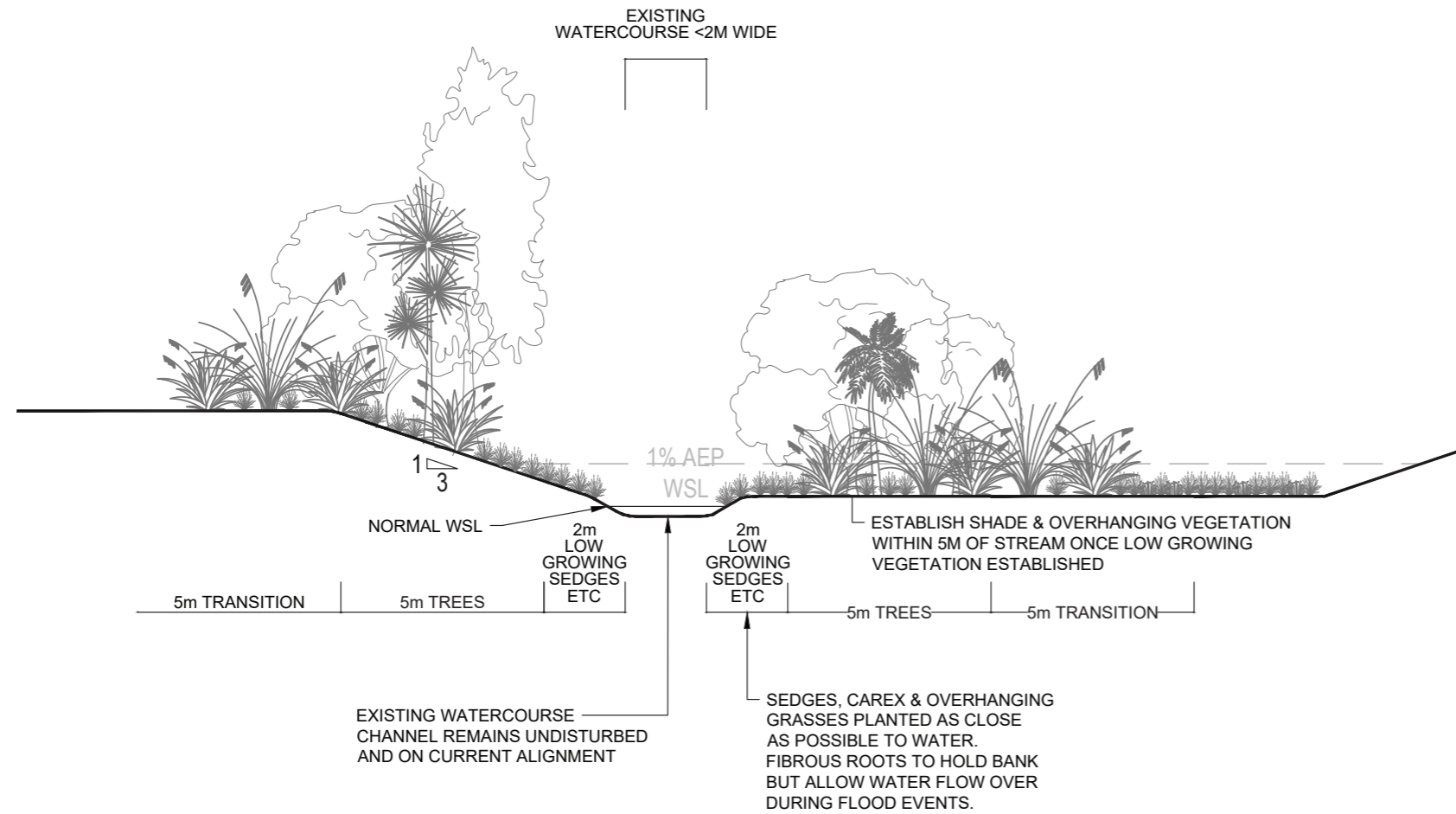

TYPICAL SMALL STREAM RIPARIAN PLANTING DETAIL 1:150

Refer to GWRC Best Practice Guide for Small Stream Erosion Repair (April 2013) for willow pole planting in small streams

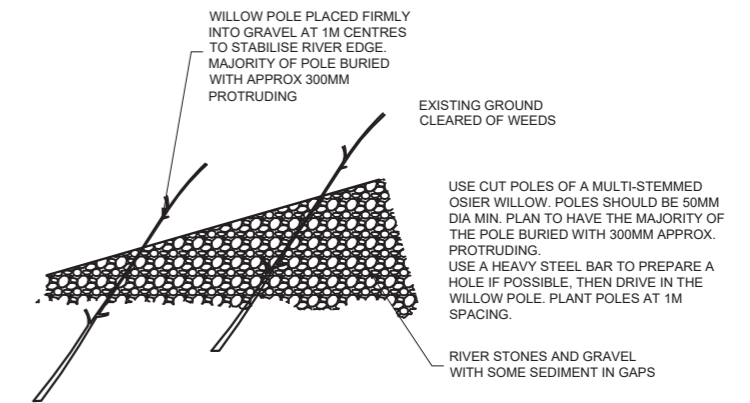

TYPICAL WILLOW POLE PLANTING DETAIL 1:20

Refer to GWRC Best Practice Guide for River Erosion Repair (April 2013) for further willow pole planting details, including willow planting on groynes.

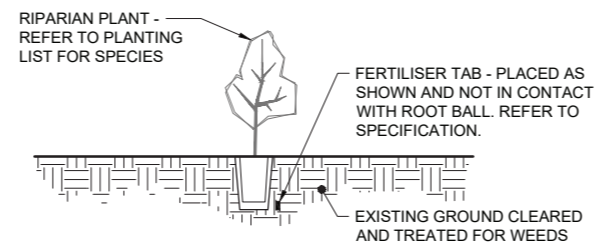

TYPICAL RIPARIAN PLANTING DETAIL 1:20

Refer to planting list 5 for species

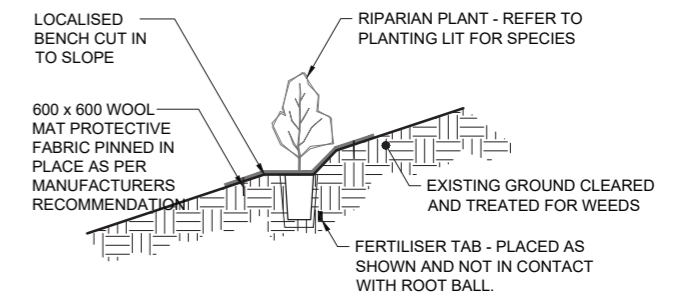

TYPICAL RIPARIAN PLANTING - GROUND SUBJECT TO EROSION 1:20

Refer to planting list 5 for species

DESIGN GUIDE

MIXED WILLOW AND NATIVE BUFFER PLANTING

Willow and native species can be intermixed in new planting where there is:

- moderate to low erosion risk,
- good soil (or ability to add soil) and
- good access for the extra site preparation and maintenance native planting needs.

Implement mixed planting where other factors help to justify or offset the extra cost of the native component, such as where:

- there is little existing native vegetation in the locality,
- a site has good soil but is exposed to strong winds, so fast-growing willows will shelter the native plants, or
- where reliable volunteer labour is available for maintenance.

Intermixing can be done in various ways, as illustrated to the right. After 15-20 years, provided that the site is reasonably stable and the front edge well protected, gradually increase the proportion of native plants by replacing some of the willows with native enhancement species. Alternatively, consider thinning patches of the willows to encourage natural regeneration of native plants in the created 'light wells'.

BUFFER ZONE PLANTING

Buffer Zone planting to be undertaken 20-30m from the front channel edge.

Option a) Willows at the front edge with blocks of native plants interspersed behind. Over time, gradually expand the native planting outwards.

Option b) Rows of willow alternating with rows of natives. Over time, replace willows at the back of the rows with natives.

Option c) Willows at the front edge with 50/50 mix of willow and native behind. This is more labour intensive but could be warranted on exposed sites where the close inter-planting will benefit natives with shade and shelter. Increase the proportion of natives gradually over time.

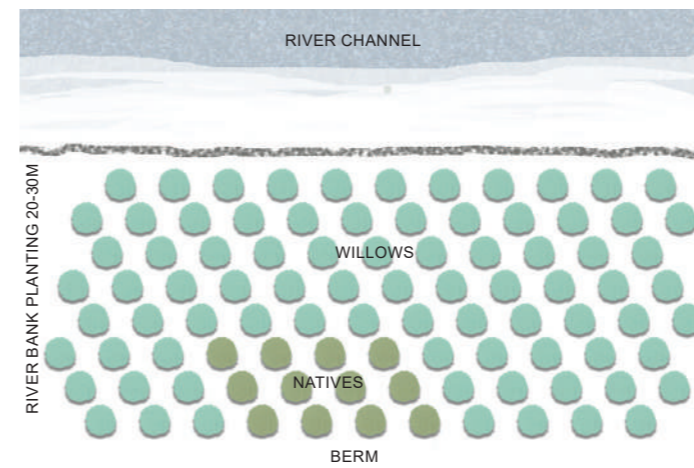

Year 1

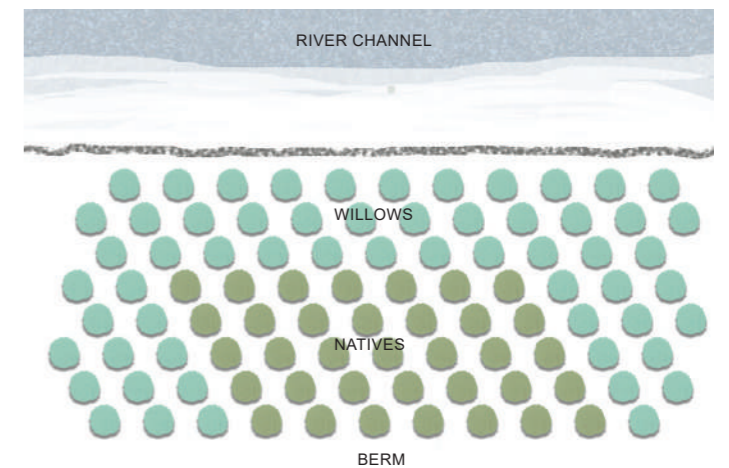
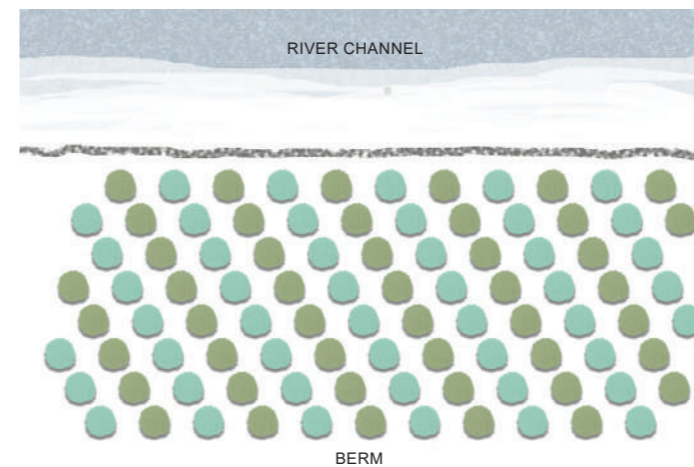

15-20 Years

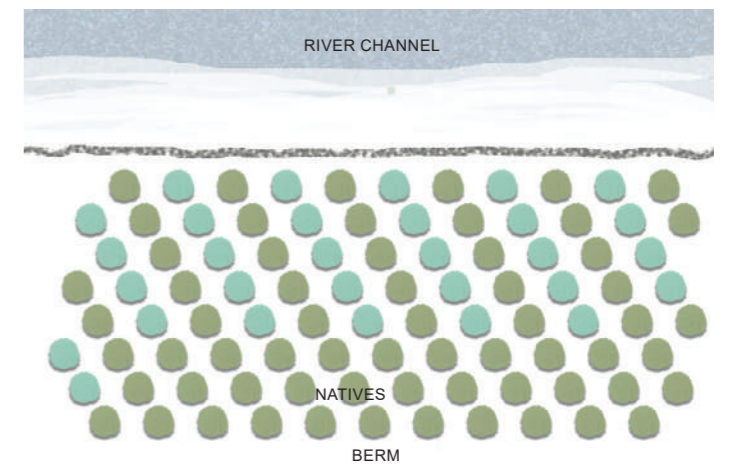

Year 10

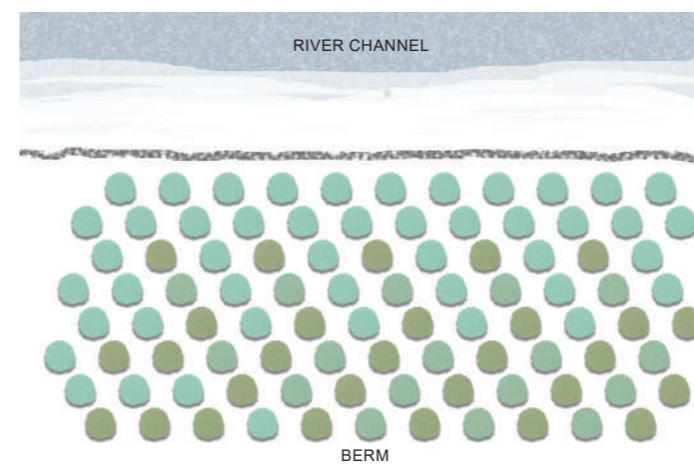

Year 1

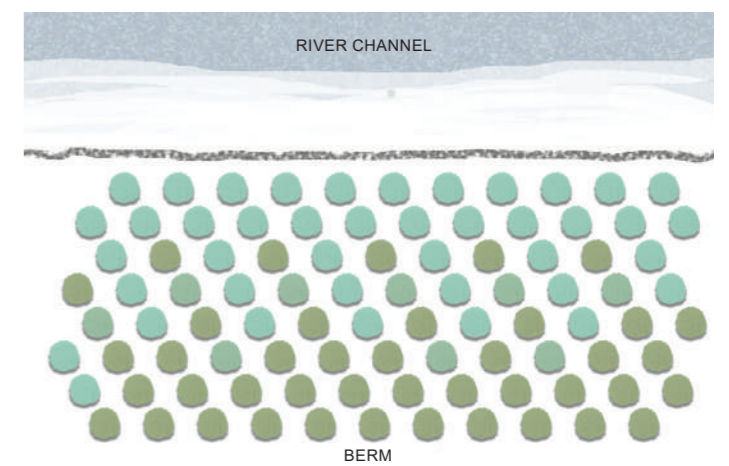

Year 10

DESIGN GUIDE

RIVER BERM PLANTING

Make use of opportunities where hard structure flood protection enables native plants to be brought closer to the river channel than might be possible where soft protection only is used.

NATIVE PLANTING WITH HARD STRUCTURE PROTECTION

Where rock rip rap or gabion baskets are used to protect river edges the buffer zone is adequately protected by the hard structure. Here soil-binding willows are not needed and native species can be planted close to the river on the berm. If construction has resulted in poor soil structure, bring in topsoil to help get the planting off to a good start.

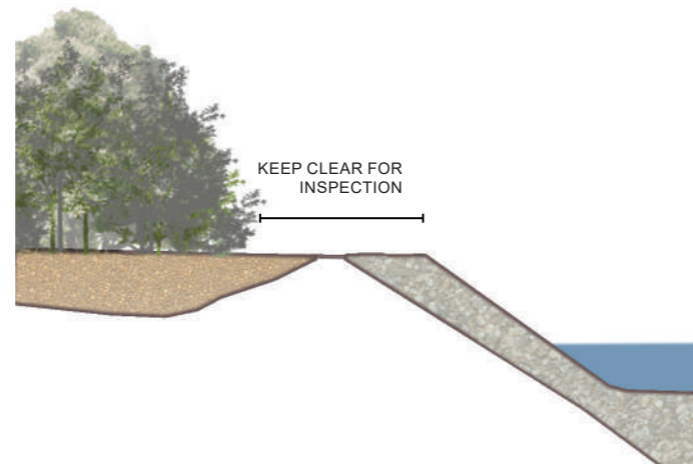

On a wide, exposed river berm, such as that pictured at right, consider limiting planting to just the hardiest of those in the following section and include toetoe and flax (see Planting List 2) for fast ground-level shelter. Alternatively, use quick-growing exotics, such as alders or poplars, to 'nurse' native plantings. Once the hardy pioneers are well-established with a closed canopy, gradually remove the nurse trees and diversify by planting more native species.



BERM PLANTING – SECOND LINE

Where willows are needed in the buffer zone consider planting a 'second line' of native planting on the berm behind. Look for opportunities where the willows shelter the berm and where there is good soil.

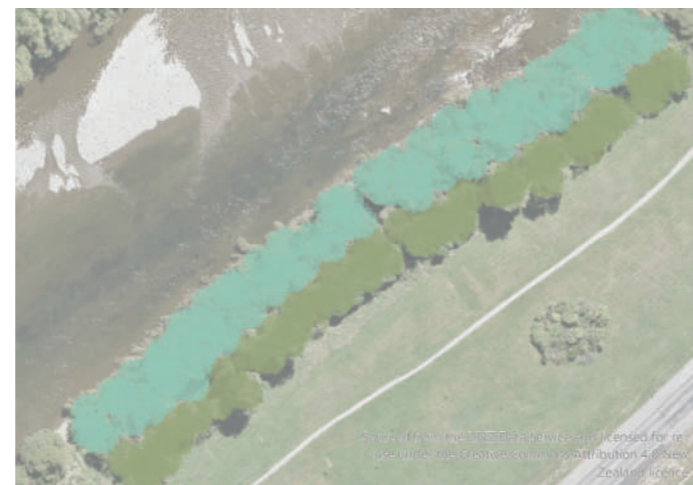

- Willows, well-established on the buffer zone
- Native planting on well prepared site in the sheltered 'lee' of the berm



Good river loam on the berm and easy drive-on access made this a good choice for a second line of native planting behind willows, especially with the ready seed source provided by the Key Native Ecosystem on the hill behind.



An initial planting of mixed pioneer species is now well established so enhancement plants can be introduced (e.g. rewarewa, totara). Natural regeneration is also occurring.

DESIGN GUIDE

RIVER BERM PLANTING

Look for opportunities for native planting on wide river berms, where clear flood overflow paths can be maintained around grouped plantings. This may not be feasible on narrow berms.

BERM PLANITNG - DISCRETE GROUPS

In some areas, the wide, open river berms can be exposed to winds funnelling down the river valley, which can cause native plants to struggle. In these situations, consider planting fast-growing tall exotic trees, such as poplars, alders or eucalypts as a nurse cover to shelter and shade native planting (see below). These tree stands can break up the wind flow and improve the visual and recreational amenity of otherwise exposed expanses of grass in the river corridor. Establish a small range of hardy native species under or in the lee of the tall exotics, then start enhancement planting of slower-growing tall native trees to eventually replace the exotic trees.

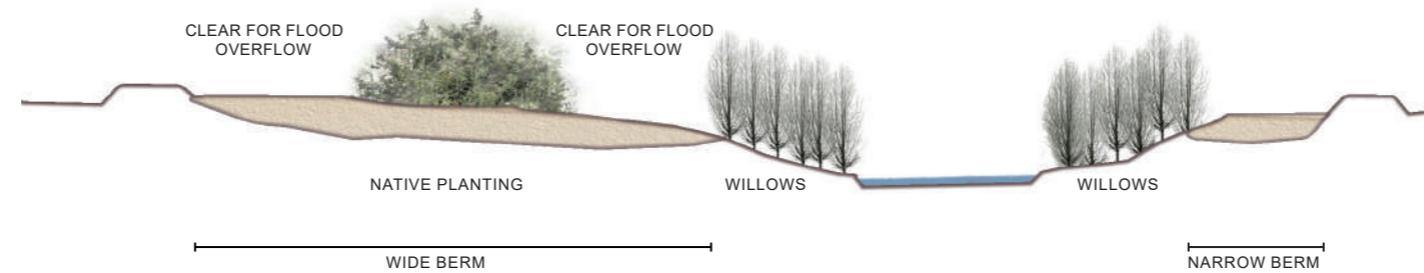

Opportunities for grouped berm plantings are present on wide berms (left) but are more limited on narrow berms (right).



5 years after planting. Fast-growing poplars now provide enough shade and shelter to prepare the site for underplanting with hardy native trees



3-4 years later. The native underplanting is coming on well but some areas have yet to close over (foreground). In another 3-5 years enhancement planting can begin.

DESIGN GUIDE

PLANTING DETAILS

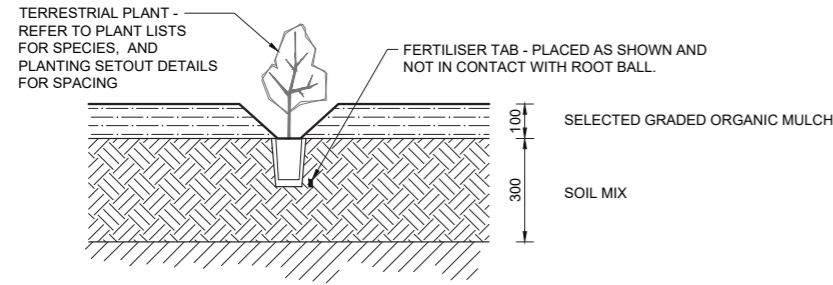

TYPICAL PLANTING IN ORGANIC MULCH DETAIL 1:20

Refer to native planting on river berms for layout

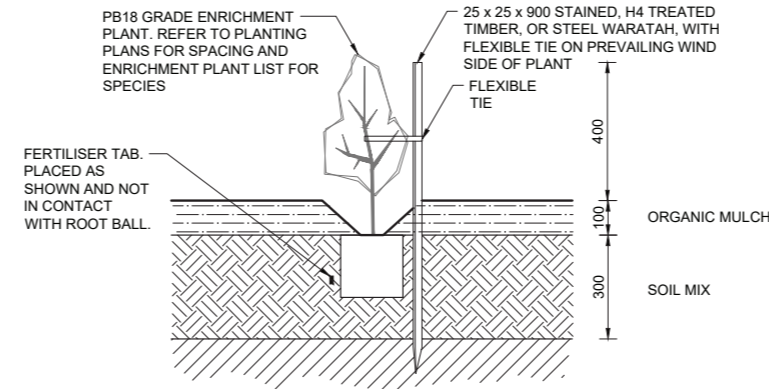

TYPICAL ENRICHMENT TREE PLANTING DETAIL 1:20

Refer to native planting on river berms - enrichment planting plan for locations

SELECTING SITES FOR PLANTING

- There is no standard formula. Each site will be different. Consider the type of river, the way the local community values it, and the site-specific features – then decide your approach.
- Look for winners. Focus on sites with favourable conditions that will be practical to manage. Work with what's already there if it gives you a head start (e.g. a sheltered site in the lee of existing trees).

Think about the 'big picture' when looking for opportunities to increase native vegetation. It's useful to think about the flood protection scheme as a system of inter-related factors that affect the level of risk. For example, erosion risk increases downstream as river volume and velocity increases. Another example – there is less risk to stop banks and assets where wide river berms provide more overflow capacity.

PLANT PATTERN AND SPACING

Use different spacing for different plant types and sites: For native revegetation sites: Allow spacings of 3-10 m for large canopy and podocarp trees, i.e. 1000-100 plants per hectare. Allow 1-2 m for small trees (e.g. xx), and 1 m for shrubs and large tussocks (e.g. karamu), i.e. 10 000-2500 plants per hectare.

Waterway enhancement: For establishing dense sedge tussocks to prevent weed invasion and provide shelter, shade and a source of insects for in-stream wildlife. Allow 0.5 m for ground cover plants and small tussocks (e.g. ferns, rushes and sedges), i.e. 40 000 plants per hectare.

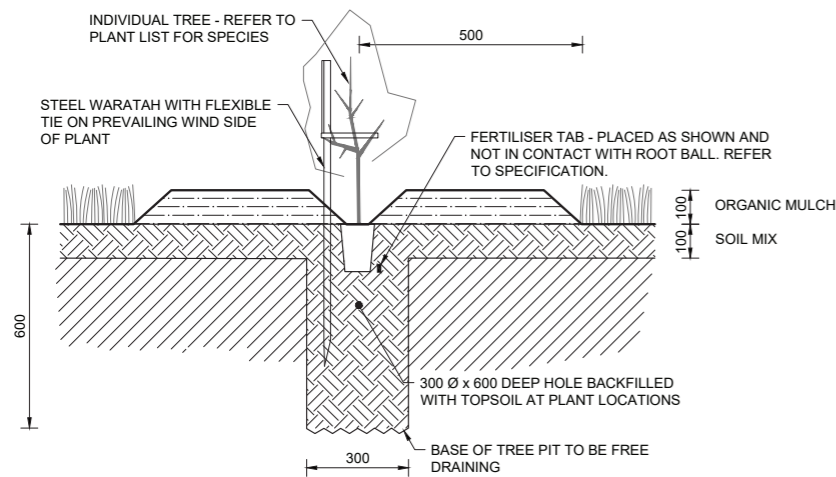

TYPICAL SPECIMEN TREE IN GRASSED AREA DETAIL 1:20

Refer to amenity planting list for species

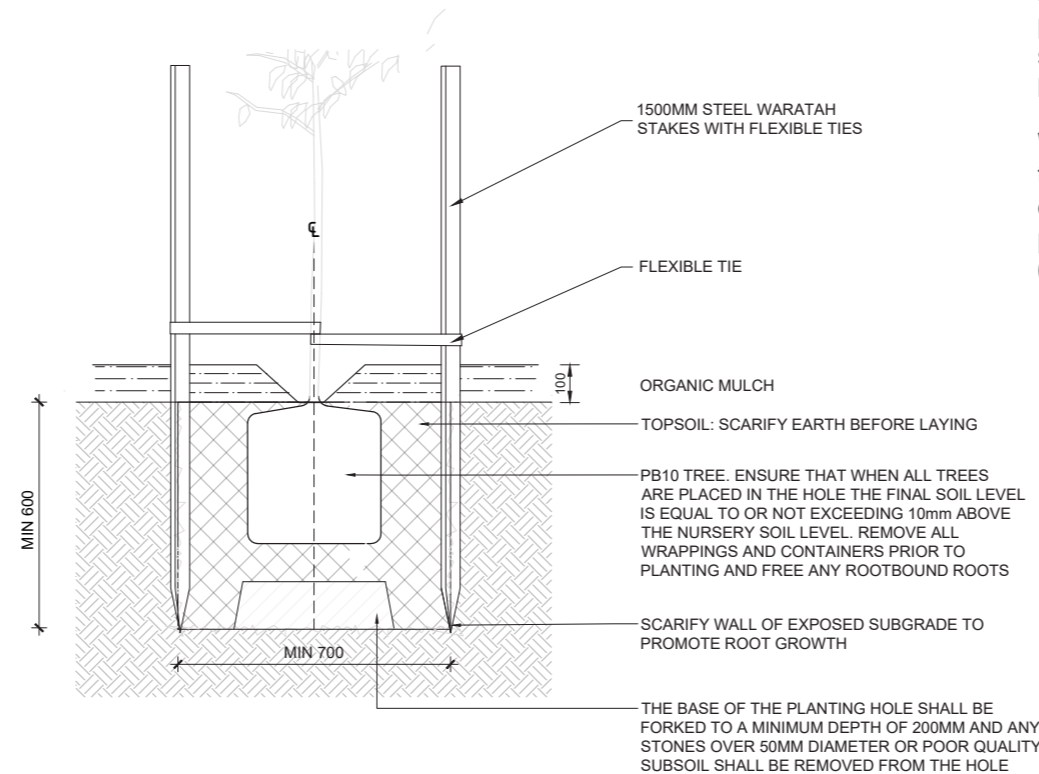

TYPICAL LARGE SPECIMEN TREE PLANTING DETAIL 1:20

For use with specimen trees for planted for shelter and amenity

Refer to amenity planting list for species

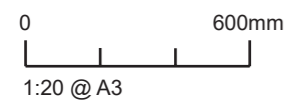

PLANTING MAINTENANCE

TIMELINE FOR ESTABLISHING NATIVE PLANTING

Adapted from “Planting Patterns and Density for Natives of Open Sites”

High Density Option (plant spacing 1-1.5m)

YEAR 1

PEST CONTROL

- Erect stock-proof fences
- Maintain grass to low levels where practical
- Control wild animals.

SPRAYING

- Blanket-spray site with herbicide preferably at least 2 weeks prior to planting.

PLANTING

- Plant mixture of hardy shrubs and trees for shelter and to bulk out site
- Aim to get at least 5000 p/ha (plant spacing less than 1.5 m)
- Plant mostly shrubs with native tree seedlings randomly mixed in at near final crop spacing of 4-600 spha (4-5 m plant spacing)
- If necessary leave planting of the tree species on severely exposed sites until shrub cover is established and providing more shelter (Years 2-3).

WEED CONTROL AND BLANKING

- Inspect site every 3-6 months
- Determine and remedy any causes of mortality. Replace dead seedlings (blanking) during the next planting season
- Re-spray areas of grass or weed regrowth before it reaches a height of 20 cm.
- Spot-spray or hand-cut brush weeds and blackberry.

YEAR 2

CONTINUING WEED CONTROL

- The need for grass control will reduce as shrub and tree crowns expand
- Continue spot-spraying or hand-cutting of woody weeds and blackberry.

YEAR 3

CANOPY CLOSURE AND SILVICULTURE

- Depending on growth rate, canopy closure should occur within 3 years, after this no further weed control will be required
- Ensure native tree species in gaps are not being overtopped by faster growing shrub hardwoods.

YEAR 4 ONWARDS

SILVICULTURE

- Enlarge gaps to ensure light wells remain above interplanted native tree species
- Continue annual inspections until tree species have grown through canopy of nurse cover



DESIGN GUIDE

WILLOW PLANTING

Willows are very effective for front-line river edge planting because:

- their fast growing root systems bind soils where erosion is a risk
- they are deciduous, which allows light for grass and other herbaceous plants to grow underneath, helping to bind top soil
- they are hardy in exposed sites
- they tolerate poor and weakly structured soil
- over time, they can help to rebuild river banks and soils by catching river-borne silt and adding organic matter from fallen leaves
- they are easy to propagate and establish with little maintenance.

Purpose-bred sterile willow hybrids that don't self-seed are now used instead of the invasive varieties used historically.

Mass willow planting provides only a limited variety of habitat and food for wildlife. Like all trees, willows are susceptible to various parasites. There is a risk of catastrophic die-back if they are used exclusively within a river corridor. Willows need to be renewed every 15-30 years.

Methods for the appropriate establishment of willows can be found in the GWRC Best Practice Guide for River Erosion Repair (April 2013).



DESIGN GUIDE

ADAPTING ESTABLISHED WILLOW PLANTING

Take advantage of the favourable conditions that develop under established willows (i.e. shade, shelter and organic topsoil content). Adapt the willow planting to accommodate more natives. It can be an effective and less risky way of bringing native plants closer to the river than planting large bare sites. Encourage natural regeneration where there are local sources of native seeds for birds to carry in, especially where access is limited. Consider planting under the willows where there is reasonable access and a lack of local seed sources.

Note: the favourable 'nurse' conditions mean that a more diverse array native species can be planted in addition to hardy pioneers. Several adaptive methods are shown below.

NATIVE REGENERATION UNDER ESTABLISHED WILLOWS



Encourage regeneration by thinning areas of willow to let in more light, especially where native seedlings are already appearing.



Over time, extend the thinned willow patches as the native patches develop, with further thinning around the edges.



Natives can regenerate under the willow canopy. Thinning patches of willow can create 'light wells' to encourage growth of the native trees in amongst the main willow block.

RIPPING INTO ESTABLISHED WILLOW

Rip strips for native planting into the willows, extending close to the river channel where there is low erosion risk.

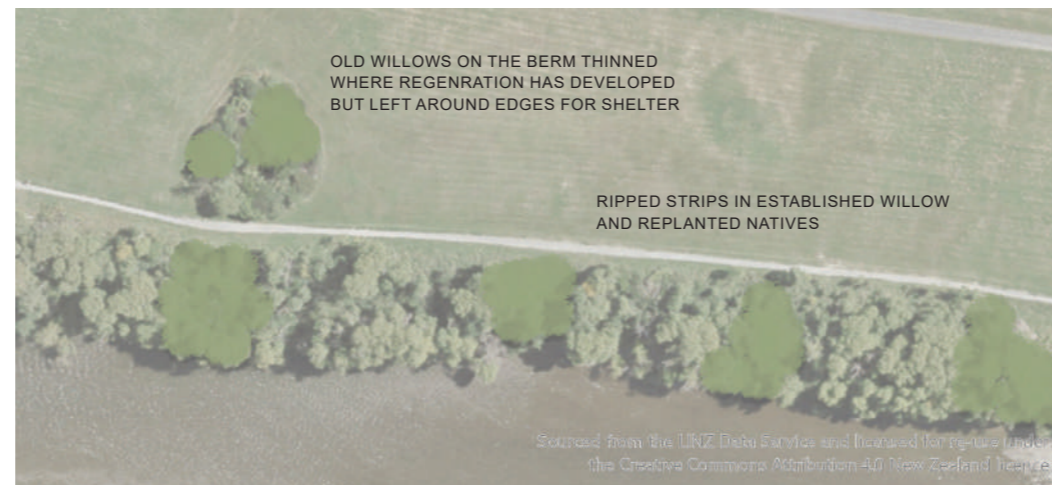

The buffer zone is sufficiently stabilised that native planting can be brought to the front edge in places. The established willows continue to protect most of the buffer zone.



Native plantings established between planted lines of willows along a reach of the Otaki River. Note the flax planting towards the back of the native planting where it is less likely to get washed away and cause downstream blockages.

DESIGN GUIDE

ADAPTING ESTABLISHED WILLOW PLANTING

INTRODUCE NATIVES WHERE ROCK GROYNE BUFFER ZONE HAS STABILISED

Where rock groynes and willows were originally put in place to stabilise and rebuild the buffer zone, look for opportunities some 10-15 years later to start introducing natives.

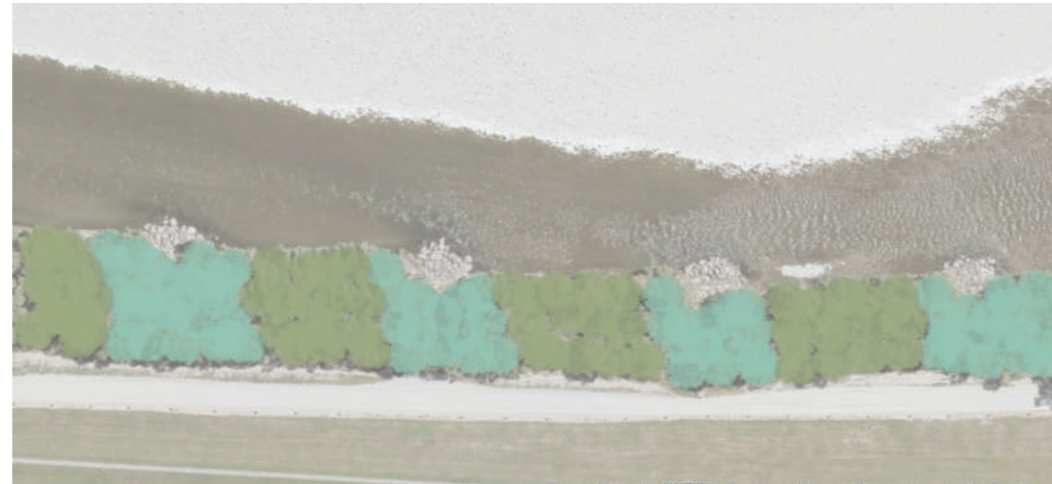

Gradually replace the willows with native plants in bands right down to the river edge on the downstream side of the groynes where erosion risk is less and sediment tends to be deposited. Keep the established willows on the more vulnerable upstream side of each groyne. Monitor closely as erosion can occur between the groynes in some situations

OLD WILLOWS IN NEED OF REJUVENATION

After 20-25 years, willows need a hard prune to rejuvenate them. Where the site is well stabilised, consider replacing a proportion with natives. Protect well-established native trees that have already regenerated and remove patches of willow to encourage native regeneration or to do native enhancement planting.



Selective replacement of willows with natives, during rejuvenation pruning.



















Native plantings established between planted lines of willows along a reach of the Otaki River. Note the flax planting towards the back of the native planting where it is less likely to get washed away and cause downstream blockages.

PLANTING LISTS

1. RELIABLE PIONEERS







Hardy, fast growing, better survival in harsh condirions and under periodic inundation

EXAMPLE/SAMPLE		BOTANICAL NAME	COMMON NAME	EVERGREEN	DECIDUOUS	SEMI-DECIDUOUS	SUN	PARTIAL SHADE	SHADE
		Aristotelia serrata	Makamako / wineberry		•		•	•	•
		Coprosma robusta	Karamū	•			•	•	•
		Cordyine. australis	Ti kōuka / cabbage tree	•			•	•	•
		Dodonea viscosa	Akeake	•			•	•	
		Hebe stricta	Koromiko / hebe	•			•	•	
		Kunzea ericoides	Kanūka	•			•	•	
		Leptospermum scoparium	Manūka	•			•	•	
		Melicytus ramiflorus	Mahoe	•			•	•	
		Myoporum laetum	Ngaio	•			•	•	
		Myrsine australis	Māpou / red matipo	•			•	•	
		Olearia paniculata	Akiraho	•			•	•	
		Plagianthus regius	Mānatu / ribbonwood			•	•	•	
		Pittosporum tenuifolium	Kōhūhū	•			•	•	
		Pittosporum eugenioides	Tarata / lemonwood	•			•	•	
		Podocarpus totara	Tōtara	•			•	•	
		Pseudopanax arboreus	Puahou / five finger	•			•	•	
		Sophora microphylla	Kowhai		•		•	•	•

PLANTING LISTS









2. NATIVE GROUND COVERS

For use at rear of buffer zone planting or on streams of less than 2m width

		BOTANICAL NAME	COMMON NAME	EVERGREEN	DECIDUOUS	SUN	PARTIAL SHADE	SHADE
		Carex secta	Sedge	•		•	•	
		Cortaderia fulvida	Toetoe	•		•	•	
		Coprosma prostrata		•		•	•	
		Hebe speciosa		•		•	•	
		Phormium cookianum	Wharariki / mountain flax	•		•	•	
		Phormium tenax	Harakeke/ flax	•		•	•	

3. COASTAL/TIDAL INFLUENCE

















Use where salt is a factor through tidal influence in the river/stream (which limits willow survival) and/or where exposed to salt-laden winds

		BOTANICAL NAME	COMMON NAME	EVERGREEN	DECIDUOUS	SUN	PARTIAL SHADE	SHADE
		Apodasmia similis	Oioi	•		•	•	
		Cyperus ustulatus	Coastal cutty grass, giant umbrella sedge	•		•	•	
		Coprosma repens	Taupata / mirror plant	•		•	•	
		Dodonea viscosa	Aleake	•		•	•	
		Juncus kraussii	Sea rush	•		•	•	
		Myoporum laetum	Ngaio	•		•	•	
		Muehlenbeckia complexa	Small-leaved pohuehue / wire vine	•		•	•	
		Phormium tenax	Harakeke/ flax	•		•	•	

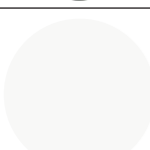
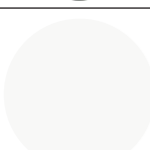
PLANTING LISTS

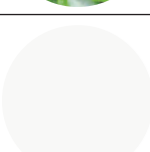
4. ENHANCEMENT PLANTING

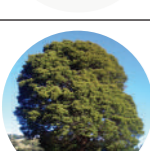

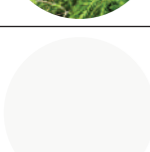
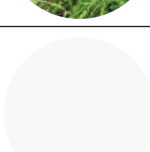







For diversity and long-lived species

		BOTANICAL NAME	COMMON NAME	EVERGREEN	SEMI - DECIDUOUS	SUN	PARTIAL SHADE	SHADE
		<i>Alectryon excelsus</i>	Titoki	•		•	•	
		<i>Beilschmiedia tawa</i>	Tawa	•		•	•	
		<i>Dacrycarpus dacrydioides</i>	Kahikatea / white pine	•		•	•	
		<i>Dacrydium cupressinum</i>	Rimu	•			•	•
		<i>Dicksonia squarrosa</i>	Wheki / rough tree fern	•			•	•
		<i>Hedycarya arborea</i>	Pigeonwood	•		•	•	
		<i>Hoheria angustifolia</i>	Narrow-leaved houhere	•		•	•	
		<i>Knightia excelsa</i>	Rewarewa	•		•	•	
		<i>Melicytus ramiflorus</i>	Mahoe / whitey wood	•		•	•	
		<i>Metrosideros robusta</i>	Northern rata	•				
		<i>Nothofagus spp</i>	Beech		•	•	•	
		<i>Plagianthus regius</i>	Lowland ribbonwood		•	•	•	
		<i>Podocarpus totara</i>	Totara	•		•	•	
		<i>Prumnopitys ferruginea</i>	Miro	•		•	•	
		<i>Prumnopitys taxifolia</i>	Matai	•			•	•

PLANTING LISTS















5. SMALL STREAM PLANTING

Grasses and low growing species to establish vegetation cover prior to tree planting

		BOTANICAL NAME	COMMON NAME	EVERGREEN	SEMI - DECIDUOUS	SUN	PARTIAL SHADE	SHADE
		Carex secta	Pukio	•		•	•	
		Carex geminata	Rautahi	•		•	•	
		Cyperus ustulatus	Giant umbrella sedge	•		•	•	
		Cordyline australis	Ti kouka	•		•	•	
		Cortaderia fulvida	Toetoe	•		•	•	
		Carex virgata	Swamp sedge	•		•	•	
		Carex maorica	Tussock Sedge	•		•	•	
		Carex lessoniana	Rautahi	•		•	•	
		Juncus pallidus	Giant Rush	•		•	•	
		Phormium cookianum	Mountain flax	•		•	•	

PLANTING LISTS

6. AMENITY AREAS

		BOTANICAL NAME	COMMON NAME	EVERGREEN	SEMI-DECIDUOUS	DECIDUOUS	NATIVE	EXOTIC
		Alectryon excelsus	Titoki	•			•	
		Dacrycarpus dacrydioides	Kahikatea	•			•	
		Eucalyptus camadulensis	Red River Gum			•		•
		Eucalyptus cordata	Heartleaf Silver Gum			•		•
		Eucalyptus nitens	Shining gum			•		•
		Eucalyptus pulchella	White Peppermint			•		•
		Pococarpus totara	Totara	•			•	
		Populus euramericana 'Veronese'	Poplar 'Veronese'			•		•
		Populus 'Crowsnest'	Poplar 'Crowsnest'			•		•
		Populus 'Kawa'	Poplar 'Kawa'			•		•
		Populus otahoua				•		•
		Populus wariata				•		•
		Plagianthus regius (regius)	Ribbonwood		•		•	

SITES OF SIGNIFICANCE TO MANA WHENUA

SITE	FURTHER INFORMATION
Hikoikoi Pā	A stockaded Ngati Awa village at the mouth of the Hutt River, western side. Puwhakaawe was the chief of this pa
Name unknown	This pā site is located by the Hutt River in Taita, on the landward side of Taita Drive
Maraenuka Pā	A temporary pā built in 1841 and burned down in 1846, on the left bank of the Hutt River at the present site of the Lower Hutt sub station, off Connelly Street. Te Kaeaea or Taringa-kuri was the chief.
Motutara Pā	This pa site was on the east side of the Hutt river opposite the former Belmont railway station.
Owhiti Pā	At the mouth of the Waiwhetu Stream. The urupa at this site is still used.
Pito-one Pā	A stockaded pa of Te Ati Awa, situated about Te Puni Street, Pito-one. The chief, Honiana Te Puni, lived at Pito-one and was the Ariki or paramount chief of the Ati Awa people in occupation of the Wellington Harbour lands at the time of the arrival of the European settlers. After the arrival of the European settlers, the Maori occupants of Pito-one re-erected their village a little distance inland at a position on the Te Tuara-whatī-o-Te Mana stream.
Pito-one Urupa	The Te Puni Street cemetery is on the eastern side of Te Puni street, Pito-one. It contains tombstones sacred to the memory of Honiana Te Puni and some of his descendants. Te Kaeaea or Taringa Kuri, the chief of Ngati Tama in the Wellington region at the time, was buried in this cemetery but his grave is not marked.
Ngutuihe Pā	On the end of a projecting spur of Puke-atua ridge below the existing Wainui-o-Mata road. Believed to have been a Ngati Ira pa. The name describes the beak of the garfish.
Te Mako	The place at Te Taitai (or Taita) where Wiremu Tako Ngatata lived, near the present Naenae railway station. The Te Ati Awa chief, Wiremu Tako Ngatata, selected the old site and lived there until the 1855 earthquake. The original pataka (storehouse) 'Nukutewhatewha' that Wiremu Tako Ngatata had built is currently located at the Dowse Museum.
Waiwhetu Pā	A Te Ati Awa pa on a sandy spit projecting into the estuary by the Waiwhetu River. It was occupied when Europeans arrived in 1840.
Puharakeketapu	Battle site on and close to the left bank of the Waiwhetu Stream. A battle took place between the allied tribes of Ngai Tahu and Ngati Kahungunu just before 1600AD when Ngai Tahu migrated to the South Island.
Paetutu Kainga	A Te Ati Awa kainga on the west bank near the Pipe Bridge. Originally it was built as a fortified pa site on an island in an area of swamp. Later it became an open village on firm ground on the right bank nearly opposite Lever Rexona.
Te Ahi-o-Manono Kainga	A former village near where British soldiers built Fort Redwood in 1854. It was located where Lower Hutt currently stands, immediately at the rear of the post office.
Hau-karetu	A Te Ati Awa village at Maoribank. The old kainga was probably located on the high terrace on the east side of the river, although it (or its cultivations) could have been on the low alluvial flats on the west
Pā Whakataka	A Ngati Ira village (exact location unknown) but situated somewhere near the confluence of the Mangaroa and Heretaunga streams.

About Boffa Miskell

Boffa Miskell is a leading New Zealand professional services consultancy with offices in Auckland, Hamilton, Tauranga, Wellington, Christchurch, Dunedin and Queenstown. We work with a wide range of local and international private and public sector clients in the areas of planning, urban design, landscape architecture, landscape planning, ecology, biosecurity, cultural heritage, graphics and mapping. Over the past four decades we have built a reputation for professionalism, innovation and excellence. During this time we have been associated with a significant number of projects that have shaped New Zealand's environment.

www.boffamiskell.co.nz

Auckland	Hamilton	Tauranga	Wellington	Christchurch	Queenstown	Dunedin
09 358 2526	07 960 0006	07 571 5511	04 385 9315	03 366 8891	03 441 1670	03 470 0460